



# RAZER TOMAHAWK ATX

MASTER GUIDE

To build the ultimate gaming desktop, it begins with a frame that can support the performance within. Meet the **Razer Tomahawk ATX**—a mid-tower metal gaming chassis that exudes both form and function, equipped with premium features to accommodate your idea of a perfect rig, whatever it may be.

# CONTENTS

1. WHAT'S INSIDE .....	3
2. LET'S GET YOU COVERED .....	5
3. TECHNICAL SPECIFICATIONS.....	6
4. GETTING STARTED .....	7
5. INSTALLING YOUR SYSTEM.....	9
6. INSTALLING RAZER SYNAPSE 3 .....	16
7. CONFIGURING YOUR TOMAHAWK ATX.....	17
8. SAFETY AND MAINTENANCE .....	23
9. LEGALESE .....	24

# 1. WHAT'S INSIDE

- Razer Tomahawk ATX-Gaming Chassis

Model No. RZ21-0142

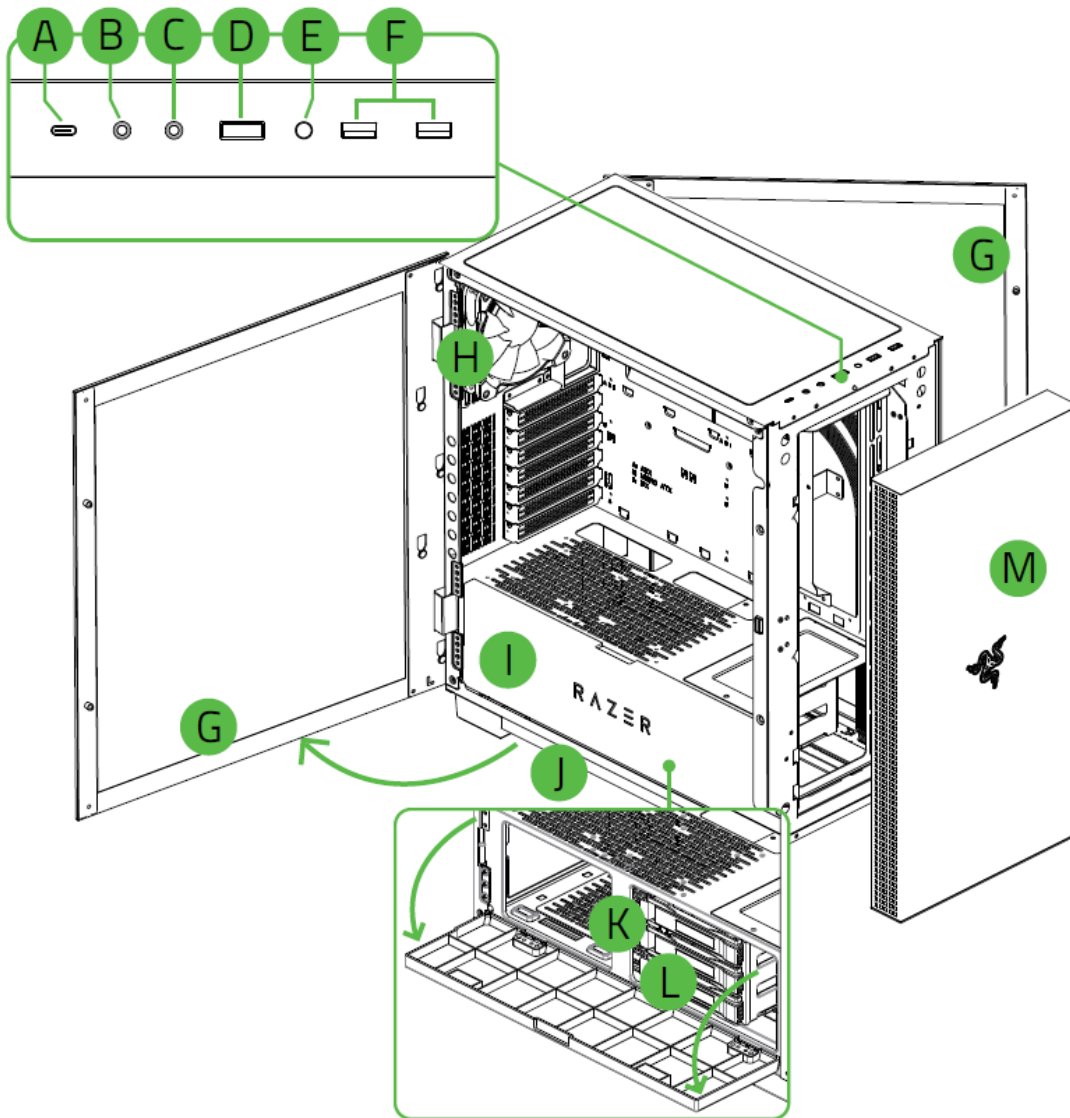

- A.** USB Type C port (up to 3.2 Gen 2)
- B.** 3.5mm audio jack
- C.** 3.5mm mic jack
- D.** Power Button
- E.** Reset Button
- F.** USB Type A ports (up to 3.2 Gen 1)
- G.** Detachable swivel glass doors

- H.** 120mm fan
- I.** Inner flip panel
- J.** Underglow lighting Powered by Razer Chroma RGB
- K.** Removable HDD / SSD trays x3
- L.** Movable drive rack
- M.** Detachable front panel

▪ Accessories Box\*

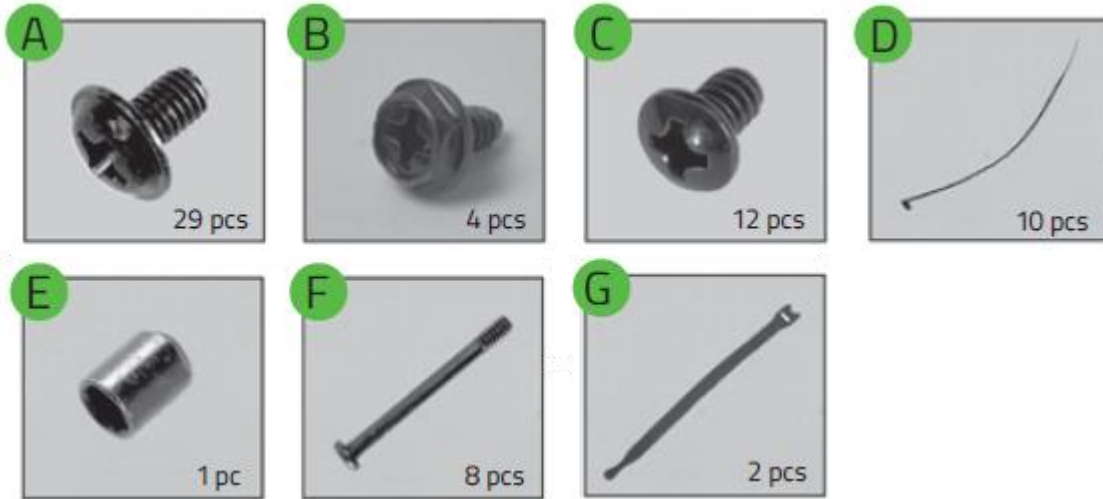

- A. Screws for motherboard and 2.5" SSD mount x29
- B. Screws for PSU mount x4
- C. Screws for 3.5" HDD mount x12
- D. Cable ties x10
- E. Tool for standoff bolt
- F. Screws for fan mount x8
- G. Hook and loop straps x2

*\*Extra items included for spare parts*

---

## 2. LET'S GET YOU COVERED

You've got a great product in your hands, complete with a 1-year limited manufacturer's warranty\*. Now maximize its potential and score exclusive Razer benefits by registering at [razerid.razer.com](https://razerid.razer.com)

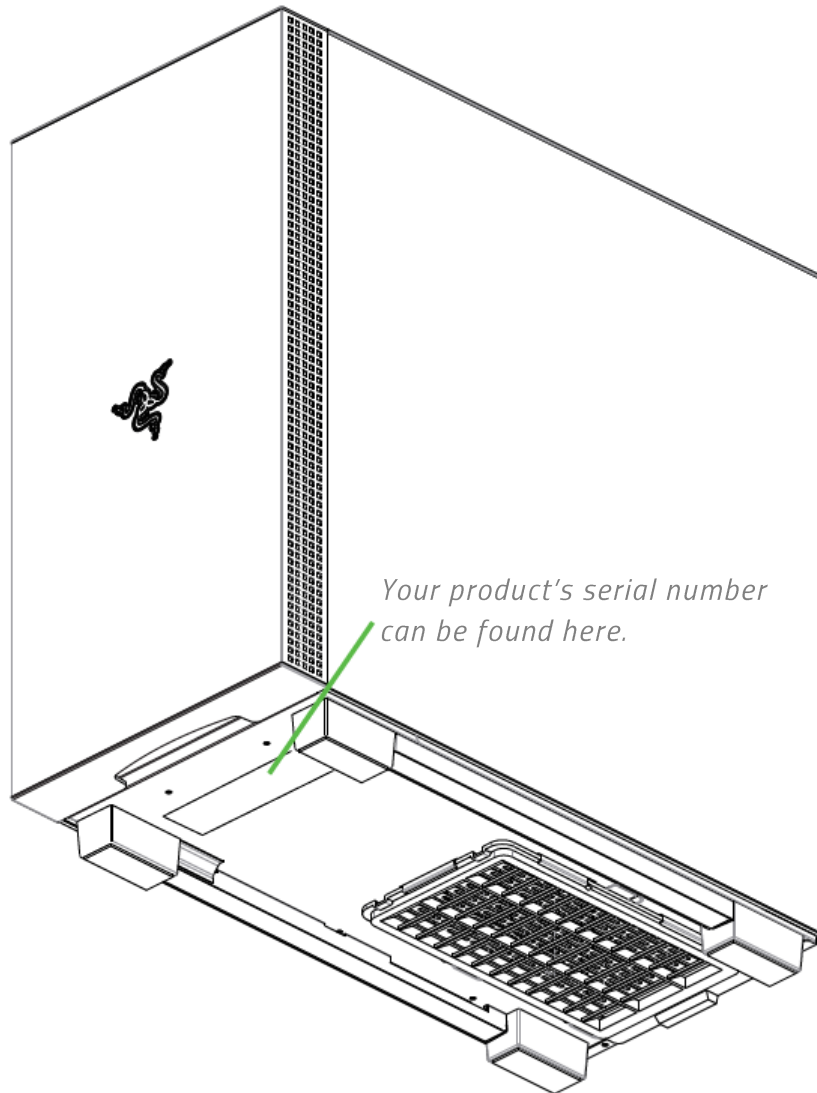

*\*Warranty may vary by region and is subject to applicable local law.*

Got a question? Ask the Razer Support Team at [support.razer.com](https://support.razer.com)

---

### 3. TECHNICAL SPECIFICATIONS

Model	Razer Tomahawk ATX
Product Number	RC21-01420100-R3M1
Chassis Form Factor	Mid-Tower
Supported Motherboards	E-ATX, ATX, Micro-ATX, Mini-ITX
Case Material	SPCC Steel (0.8mm) Thick and All Tempered Glass Side Panels
# of Expansion Slots	7 Expansion Slots
# of Supported Drives	3x 3.5" or 2.5" HDD or SSD 2x 2.5" SSD
Radiator Compatibility	Up to 360mm
Maximum CPU Cooler Height	Up to 176mm
Maximum GPU Length	Up to 384mm
Maximum PSU Length	ATX, Up to 210mm
Front Panel I/O	2x USB3.2 Gen1 Type-A Ports 1x USB3.2 Gen2 Type-C Port 1x Dedicated Microphone Port 1x Microphone and Headphone Combo Port 1x Power Button 1x Reset Button
RAZER Chroma™ Support	Razer Chroma™ Underglow
Warranty	1 Year
Case Dimensions	Height: 19.47 inches (494.6 mm) Width: 9.26 inches (235.4 mm) Depth: 18.70 inches (475 mm)
Weight	29.76 Lbs   13.5 Kg

---

## 4. GETTING STARTED

1. Remove the front panel using the bottom release handle.

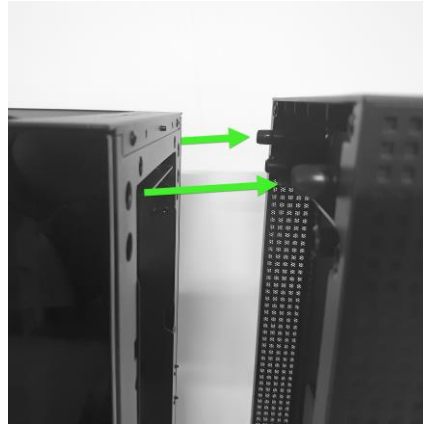

2. Open both detachable swivel glass doors, and then lift up to remove them.

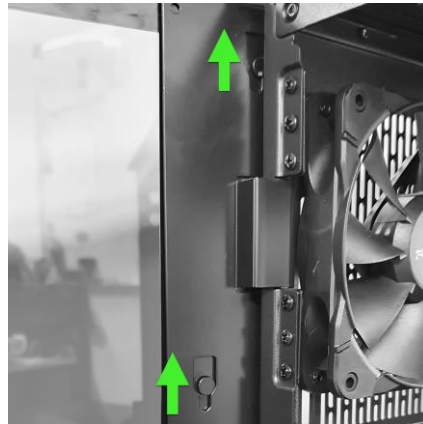
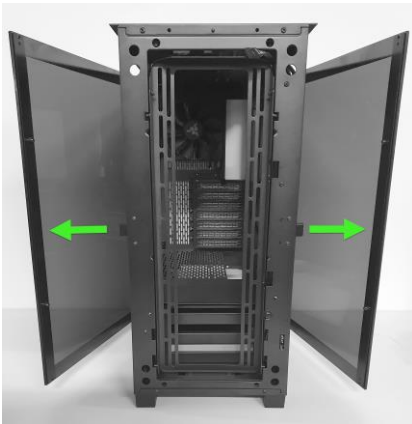

3. Open the inner flip panel.

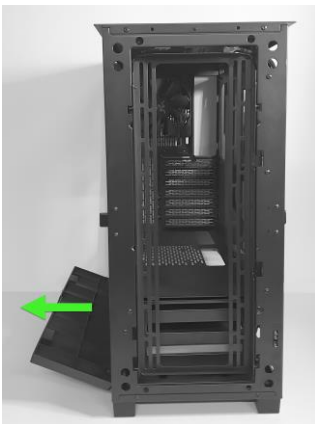

4. Remove the accessories box from the drive tray.

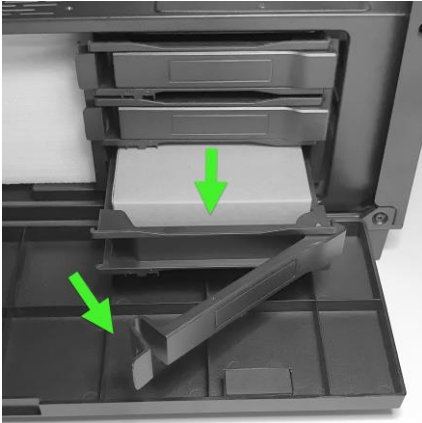

5. Detach the cable management cover and motherboard cover by removing their screws.



---

## 5. INSTALLING YOUR SYSTEM

### MOTHERBOARD INSTALLATION

Use the included tool to screw in the standoff bolts, and then screw in the motherboard.

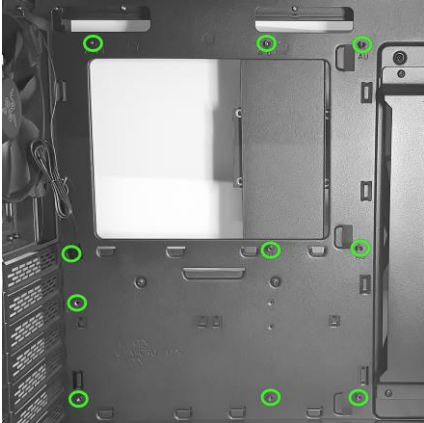

If you are using an E-ATX motherboard, rotate the cable guide 180 degrees.

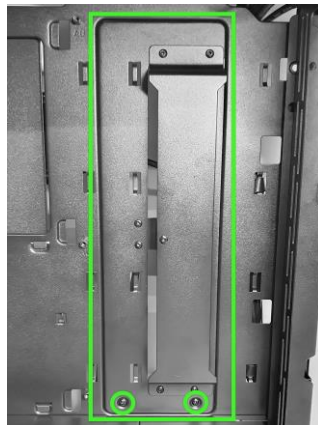

*Please refer to your motherboard's user manual on how to install the IO cables for the chassis' top control panel.*

## POWER SUPPLY UNIT (PSU) INSTALLATION

Loosen the screw and then slide the drive rack forward.

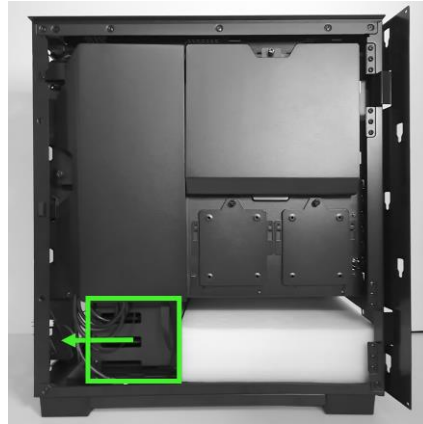
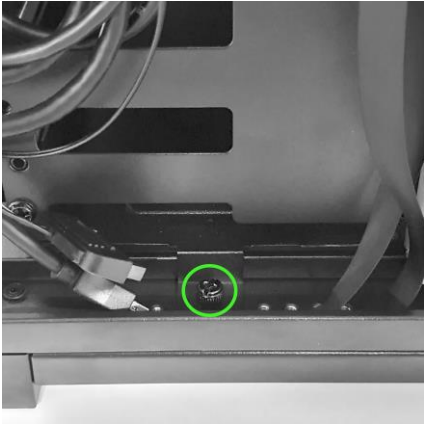

Remove the foam then return the drive rack and screw to its original position.

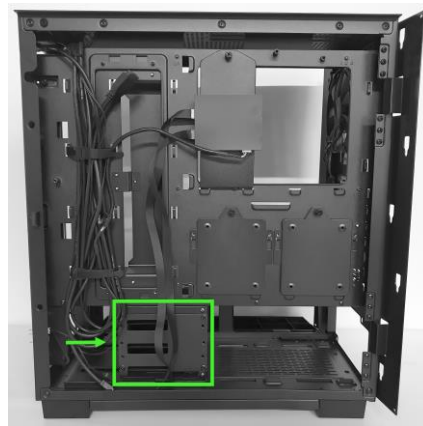
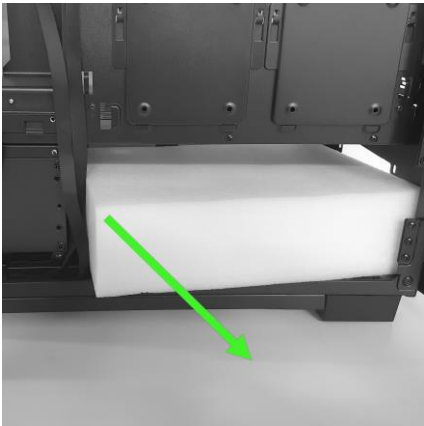

Insert the PSU from the left side of the case and then use the included screws to hold it in place.

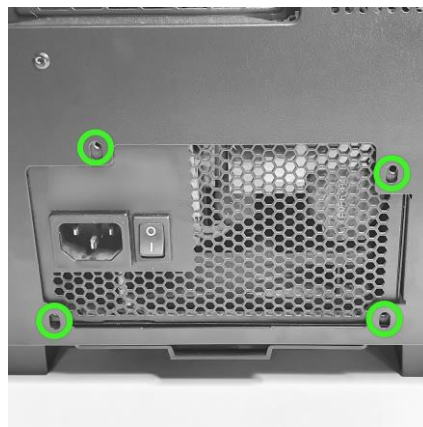
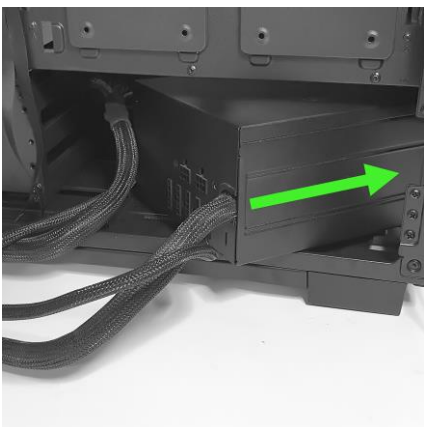

## STORAGE DRIVE INSTALLATION

Push the fastener to unlock and then carefully pull out the tray.

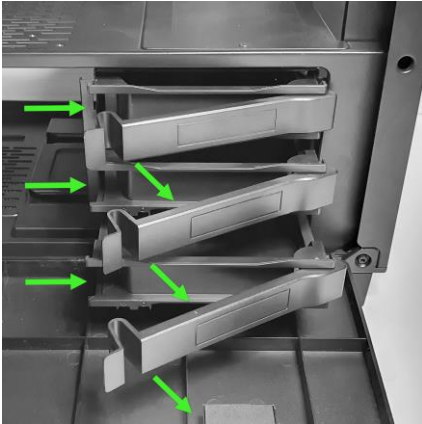

Place the storage drive on the tray and then insert the included screws from the bottom if you are using a 2.5" or from the sides if you are using a 3.5" drives.

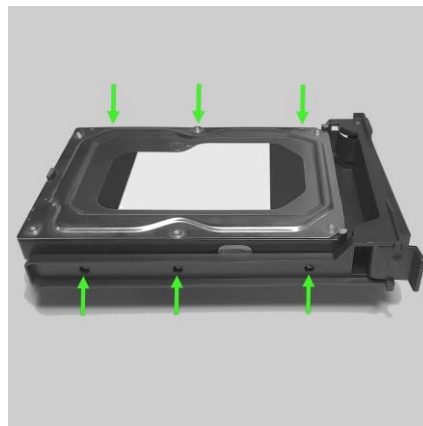

You can adjust the position of the drive rack to give additional clearance for a radiator and/or fan. To do so, simply remove the screw located on the left side of the rack, slide it, and then put back the screw.

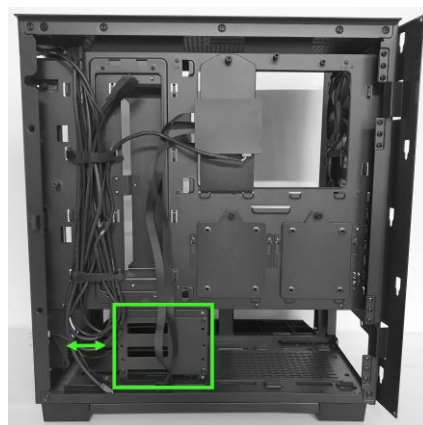
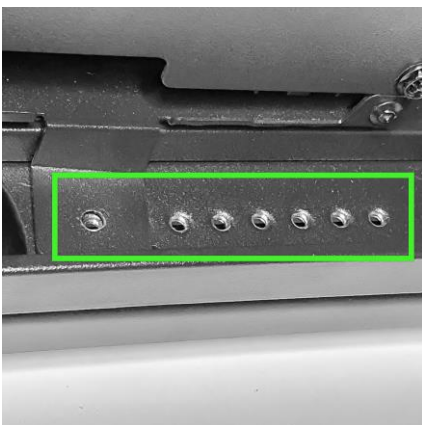

## 2.5" DRIVE INSTALLATION

Detach the 2.5" drive plate located at the left side of the chassis by removing its screw and sliding it up.

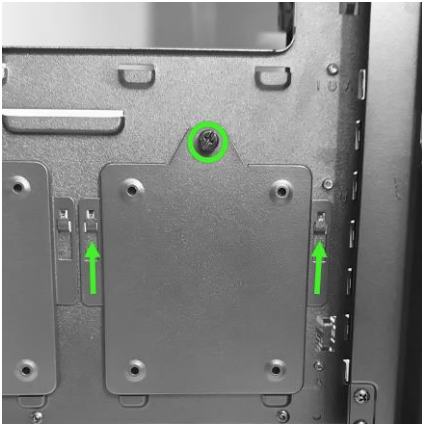

Place the 2.5" drive on the plate, then insert the included screws from the bottom.



Reattach the plate to the chassis then hold it in place using the screw.

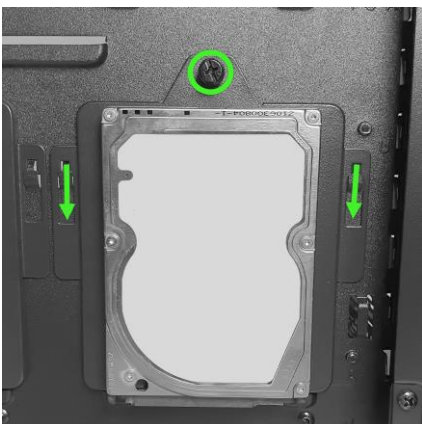

## FAN INSTALLATION

The front of the chassis has an adjustable fan tray that can be positioned in 2 different styles.

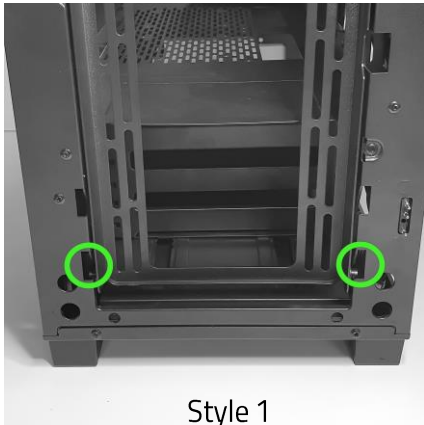

Style 1



Style 2

Styles 1 can fit only 120mm fans while styles 2 can fit up to 140mm fans.



Style 1



Style 2

To remove the fan tray, loosen the screws from both sides of the chassis and then pull it out.

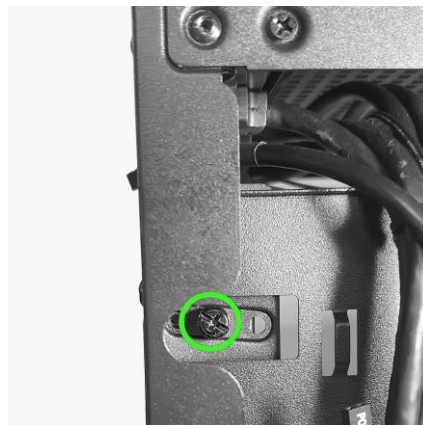
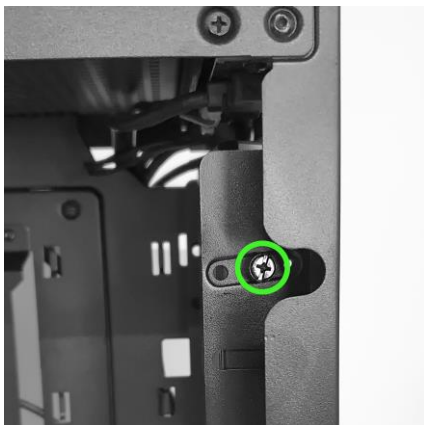

You can also mount radiators on the fan tray however, you will need to remove the drive tray shroud to fit a 120x360mm radiator. To remove the cover, simply loosen the screw from the right side of the chassis.



Two 120mm fans or two 140mm fans can be mounted on the top of the chassis. You can also mount a radiator depending on the size of your other components.

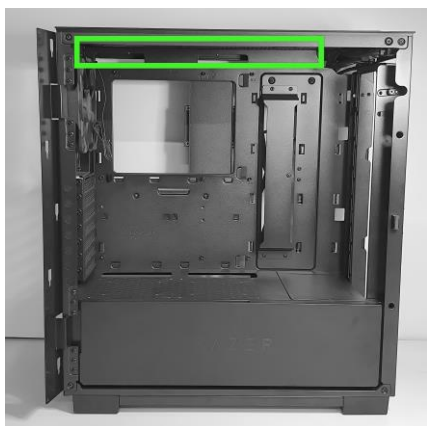

To screw in the fans, you will need to remove the chassis' top filter.

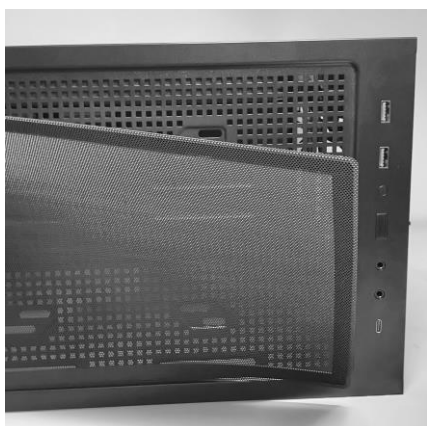

Up to two 120mm fans can be mounted on the top of the PSU shroud using the included screws.



## DUST FILTERS MAINTENANCE

There are dust filters located at the top and bottom of the chassis. Keep your chassis in optimal temperature by cleaning these dust filters as often as possible.

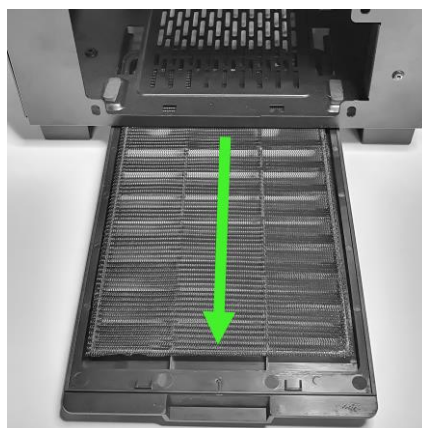

---

## 6. INSTALLING RAZER SYNAPSE 3

Razer Synapse 3 allows your chassis and other supported Razer peripherals to download drivers and firmware updates. Razer Synapse 3 also enables your custom settings to be stored on cloud servers so that they can be accessed anytime, anywhere. To start using Razer Synapse 3, follow these steps:

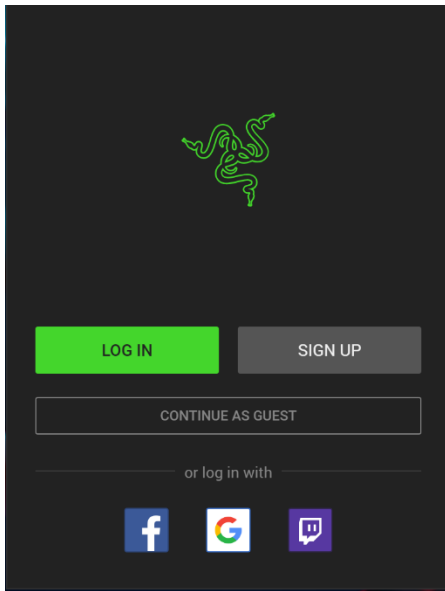

1. Make sure your computer has an active internet connection.
2. Install Razer Synapse when prompted\* or download the installer from [razer.com/synapse](http://razer.com/synapse).
3. Sign up for a Razer ID or log in with an existing account\*\*.
4. Wait until Razer Synapse 3 automatically downloads and installs the necessary drivers.

*\*Applicable for Windows 8 or later*

*\*\*You may also continue as a guest; however, you won't be able to store any of your settings to the cloud.*

---

## 7. CONFIGURING YOUR TOMAHAWK ATX

**i** *Disclaimer: The features listed here require you to log into Razer Synapse 3. These features are also subject to change based on the current software version and your Operating System.*

### SYNAPSE TAB

The Synapse tab is your default tab when you first launch Razer Synapse.

#### Dashboard

The Dashboard subtab is an overview of Razer Synapse where you can access all your Razer devices, modules, and online services.

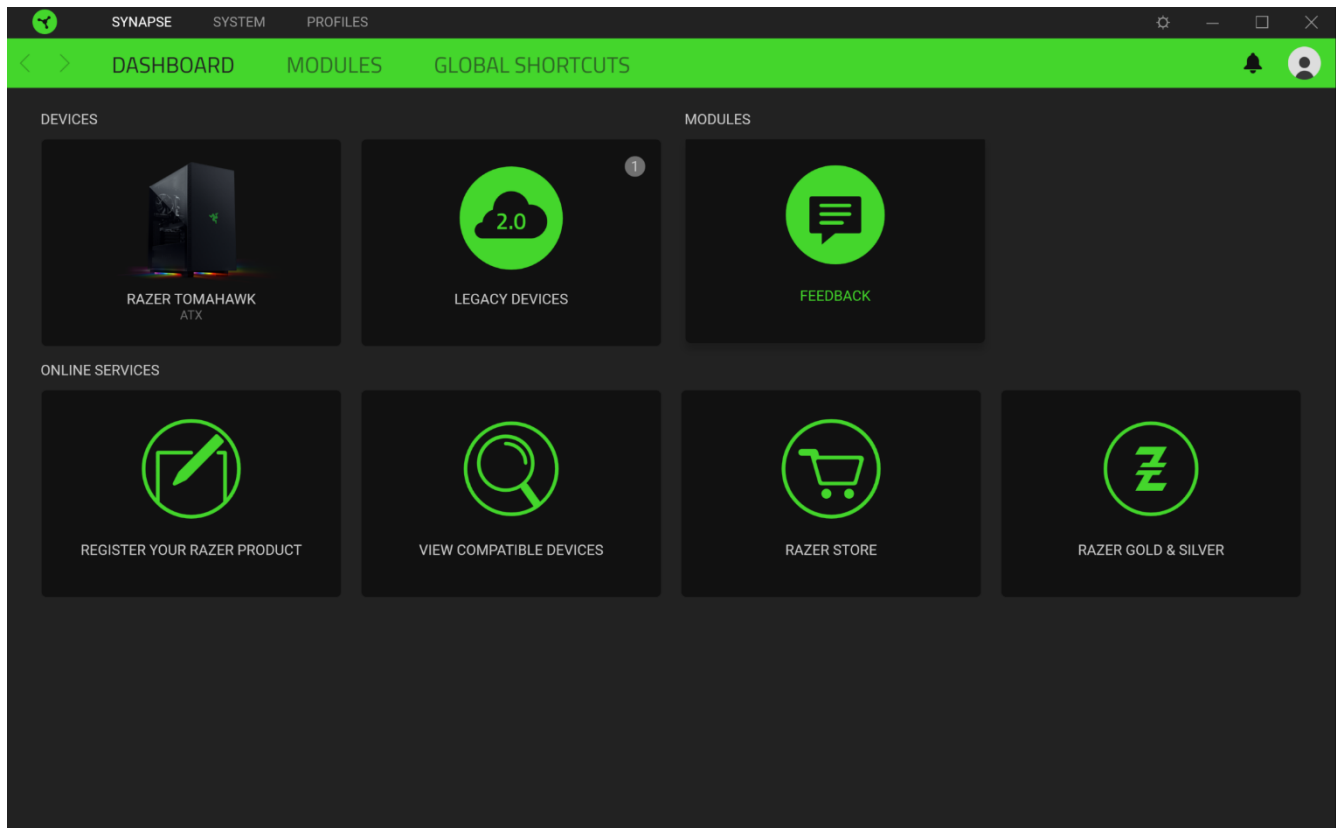

## SYSTEM

The System tab is the main tab for your gaming chassis. This tab allows you to customize its brightness, lighting effects, and power saving feature. Changes made under this tab are automatically saved to your system and cloud storage.

### Lighting

The Lighting subtab enables you to modify your Razer device's light settings.

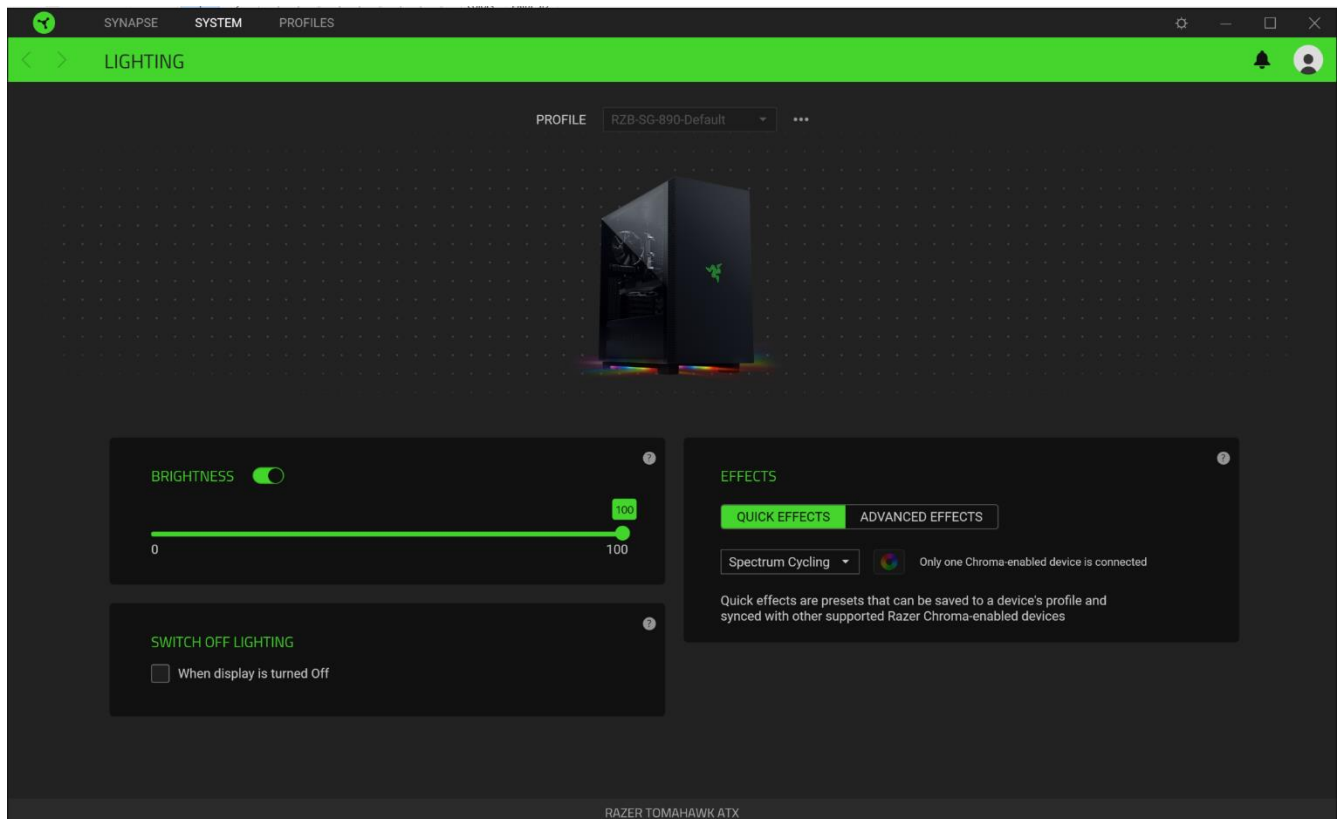

### *Brightness*







You can turn off the lighting on the gaming chassis by toggling the Brightness option or increase/decrease the luminance using the slider.

### *Switch Off Lighting*

This is a power saving tool which allows you to disable the lighting on the gaming chassis in response to your display turning off.

## Effects

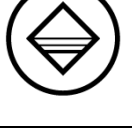
A number of effects can be selected and applied to your gaming chassis' lighting, as listed here:

	Name	Description	How to set up
	Audio meter	The LEDs will light up according to the audio level with a default spectrum of colors	Select a Color Boost level
	Breathing	The lighting fades in and out of the selected color(s)	Select up to 2 colors or randomize colors
	Fire	The LEDs will light up in warm colors to mimic the motion of flames	No further customization required
	Spectrum cycling	The lighting will cycle between 16.8 million colors indefinitely	No further customization required
	Starlight	Each LED will have a chance of fading in and out at a random time and duration	Select up to 2 colors or randomize colors and select a duration
	Static	The LEDs will remain lit in the selected color	Select a color
	Wave	The lighting will scroll in the direction selected	Select either left-to-right or right-to-left wave direction

If you have other supported Razer Chroma-enabled devices, you can synchronize their quick effects with your Razer device by clicking the Chroma Sync button (  ).

## Advanced Effects

The Advanced Effects option allows you to choose a Chroma Effect you want to use on your Razer Chroma-enabled peripheral. To start making your own Chroma Effect, simply press the Chroma Studio button (  ). [Click here to learn more about the Chroma Studio](#)



## PROFILES TAB

The Profiles tab is a convenient way of managing all your profiles and linking them to your games and applications.

### Devices

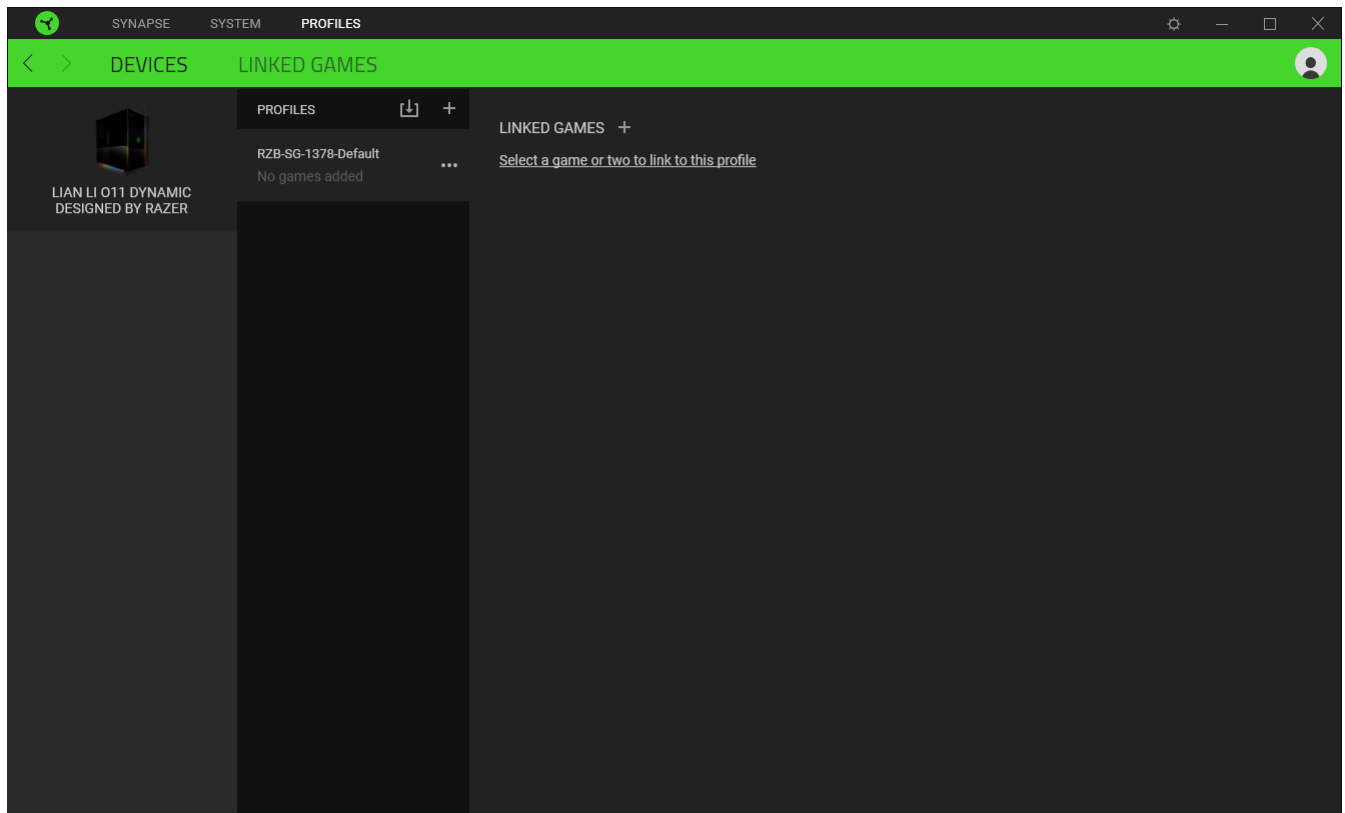
View which Razer device is using a specific profile using the Devices subtab.



You can import Profiles from your computer or from the cloud through the import button (  ) or create new profiles within the selected device using the add button (  ). To rename, duplicate, export, or delete a profile, simply press the Miscellaneous button (  ). Each profile can be set to automatically activate when you run an application using the Linked Games option.

## Linked Games

The Linked Games subtab gives you the flexibility to add games, view devices that are linked to games, or search for added games. You can also sort games based on alphabetical order, last played, or most played. Added games will still be listed here even if it is not linked to a Razer device.

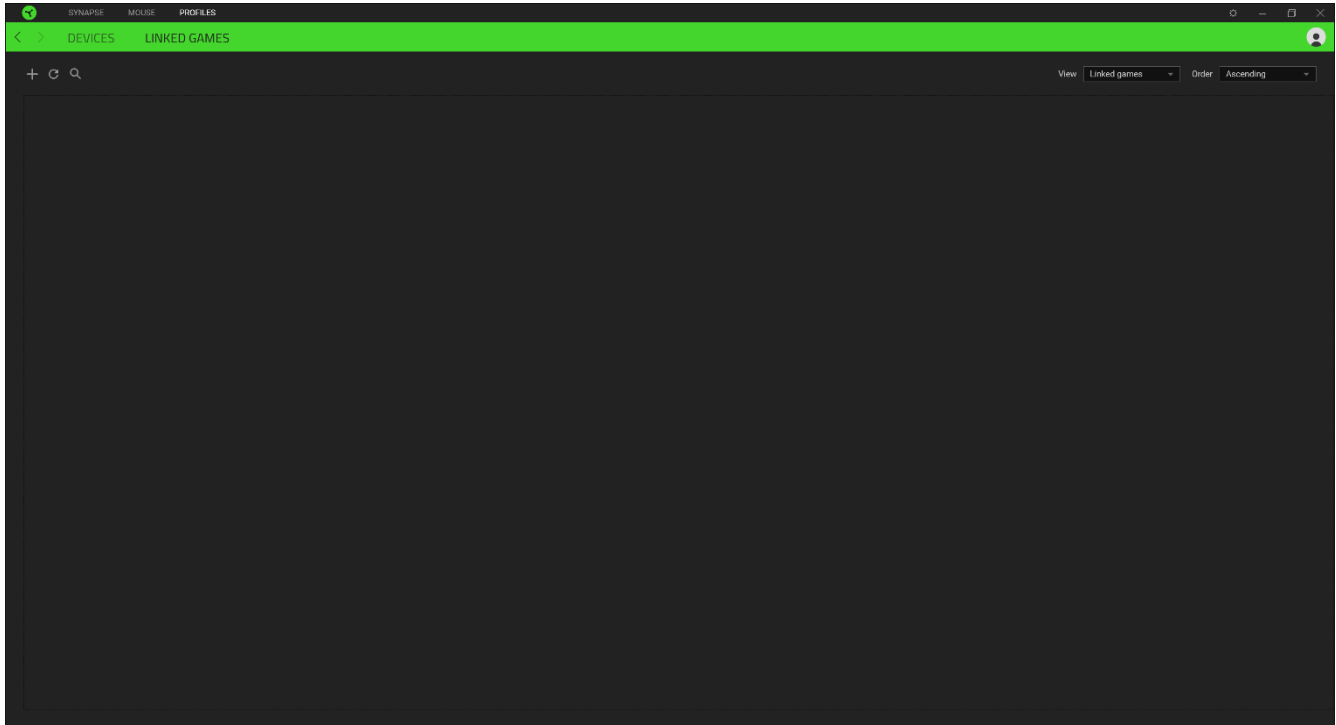

To link games to connected Razer devices, simply click on a game from the list, and then click **Select a device and its profile to launch automatically during gameplay** link to select the Razer device it will link with. Once linked, you may click on the Miscellaneous button ( ●●● ) of the corresponding device to select a specific profile.

## SETTINGS WINDOW

The Settings window, accessible by clicking the (⚙️) button on Razer Synapse, enables you to configure the startup behavior and display language of Razer Synapse, view the master guides of each connected Razer device, or perform factory reset on any connected Razer device.

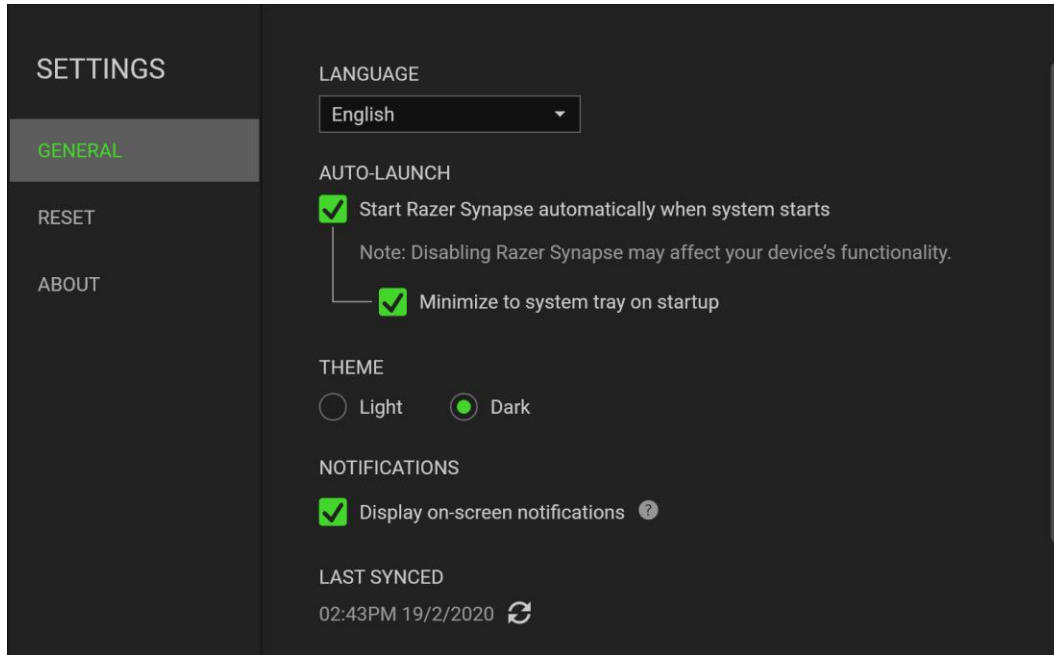

### General tab

The default tab of the Settings window. The General tab enables you to change the software's display language, start-up behavior, and display theme. You may also manually sync your profiles to the cloud (↻) or view the master guide of all connected Razer devices and installed modules.

### Reset tab

The Reset tab allows you to perform a factory reset on any connected Razer device and/or reset Razer Synapse tutorials to acquaint yourself again with Razer Synapse's new features on its next launch.



*Note: Performing a factory reset on devices without on-board memory will only create a new profile for your device on Razer Synapse 3 using the default settings.*

### About tab

The About tab displays brief software information and copyright statement and provides relevant links for its terms of use. You may also use this tab to check for software updates, or as a quick access to Razer's social communities.

---

## 8. SAFETY AND MAINTENANCE

### SAFETY GUIDELINES

In order to achieve maximum safety while using your Razer Tomahawk ATX, we suggest that you adopt the following guidelines:

1. Place the chassis on a clean and stable surface that allows adequate air ventilation.
2. Don't use or place the chassis and any of its components near water, moisture, or other wet surfaces; or place the chassis near any heat, naked flame, or other hot surfaces such as radiators, stoves, fireplaces, and candles.
3. Use caution when operating the desktop PC to avoid electrical shock or damage, such as unplugging the power supply during thunderstorms, ensuring that your hands are dry before using (and handling) the desktop PC, keeping it away from any source of liquid and/or heat source, and using all other reasonable precautions needed under the circumstances.
4. When connecting external devices to your desktop PC, carefully plan how the wires will be placed. Protect any connected cables from being trod on or pinched, particularly at plugs, convenience receptacles, or the point where they exit from.
5. Take extra caution when removing and/or reattaching the glass panel. Once removed, place the glass panel on a stable surface first before taking any action on its internal components.
6. When unplugging any connected devices and/or cables, always pull the cable or device's plug or connector. Don't forcefully tug on its cord.
7. Don't place any heavy items on top of the chassis.
8. Make sure that the desktop PC is off, unplugged from the outlet, and that all connected devices are powered off and unplugged (if any) before installing or uninstalling any internal component to and/or from the chassis.

---

## 9. LEGALESE

### **COPYRIGHT AND INTELLECTUAL PROPERTY INFORMATION**

©2020 Razer Inc. All rights reserved. Razer, the triple-headed snake logo, Razer logo, "For Gamers. By Gamers.", and "Razer Chroma" logo are trademarks or registered trademarks of Razer Inc. and/or affiliated companies in the United States or other countries.

Razer Inc. ("Razer") may have copyright, trademarks, trade secrets, patents, patent applications, or other intellectual property rights (whether registered or unregistered) concerning the product in this Master Guide. Furnishing of this Master Guide does not give you a license to any such copyright, trademark, patent or other intellectual property right. The Tomahawk ATX (the "Product") may differ from pictures whether on packaging or otherwise. Razer assumes no responsibility for such differences or for any errors that may appear. Information contained herein is subject to change without notice.

### **LIMITED PRODUCT WARRANTY**

For the latest and current terms of the Limited Product Warranty, please visit [razer.com/warranty](https://razer.com/warranty).

### **LIMITATION OF LIABILITY**

Razer shall in no event be liable for any lost profits, loss of information or data, special, incidental, indirect, punitive or consequential or incidental damages, arising in any way out of distribution of, sale of, resale of, use of, or inability to use the Product. In no event shall Razer's liability exceed the retail purchase price of the Product.

### **GENERAL**

These terms shall be governed by and construed under the laws of the jurisdiction in which the Product was purchased. If any term herein is held to be invalid or unenforceable, then such term (in so far as it is invalid or unenforceable) shall be given no effect and deemed to be excluded without invalidating any of the remaining terms. Razer reserves the right to amend any term at any time without notice.