

# HUNTER GS-01B-OP

## Installation Manual

### Explosive view

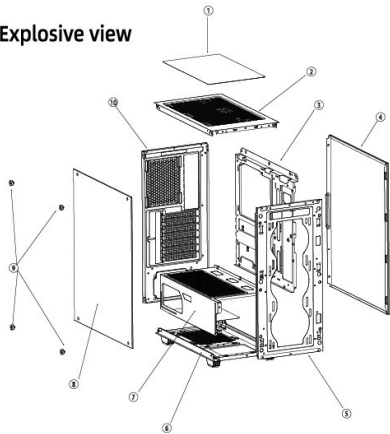

- ① Dust filter    ② Top panel    ③ M/B    ④ Right side panel    ⑤ Front plate
- ⑥ Bottom plate    ⑦ PSU cover    ⑧ Left tempered glass side panel
- ⑨ Screws for tempered glass side panel    ⑩ Rear panel

### PSU installation

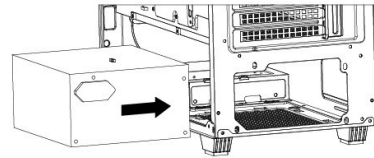

Put psu into chassis from left side

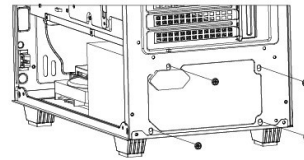

Lock 4pcs psu screws to fix psu

### M/B installation

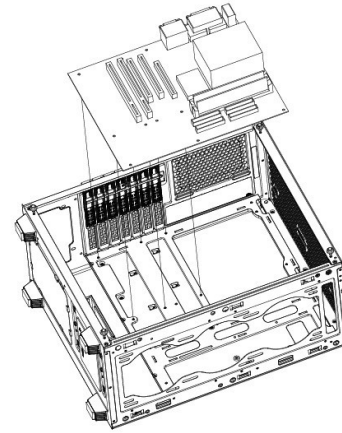

Put M/B to chassis on right position and fix screws

### HDD installation

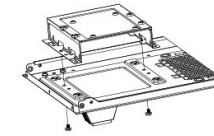

loosen 2pcs screws for HDD bracket, pull out HDD bracket



Fix HDD on bracket

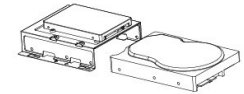

SSD installation. Fix SSD on bracket up side and lock screws first, after that fix HDD

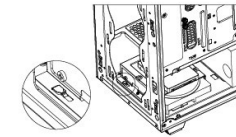

Put bracket on chassis after HDD installation, and lock 2pcs screws

### SSD installation

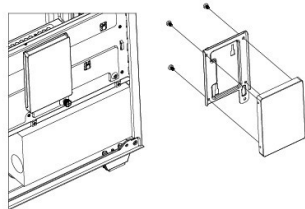

Take off SSD bracket, then fix SSD on bracket and lock bracket to previous place

### Fan and Water cooling installation

Install fan and water cooling on top panel

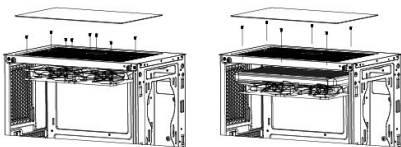

Put fan or water cooling on top panel from inner side and fix screws from outside

Install fan and water cooling on front plate

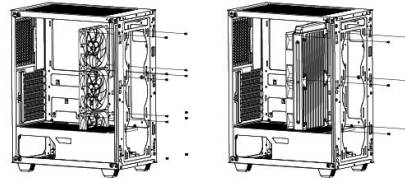

Put fan or water cooling on front plate from inner side and fix screws from outside

Install fan and water cooling on rear panel

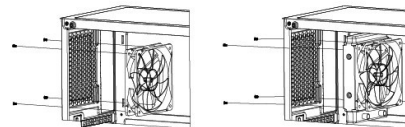

Put fan or water cooling on rear plate from inner side and fix screws from outside

### Install fan on psu cover

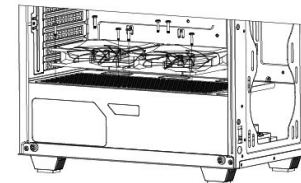

Put fan on upside of psu cover and fix screws

### Install side panel

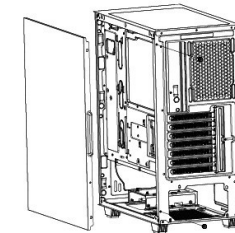

Put side panel on right position and push it, then lock 2pcs screws

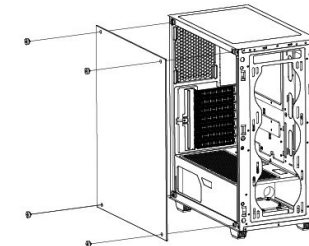

Put side panel on right position and lock 4pcs screws