

EK-Quantum Vector Strix RX 5700 +XT

GPU WATER BLOCK

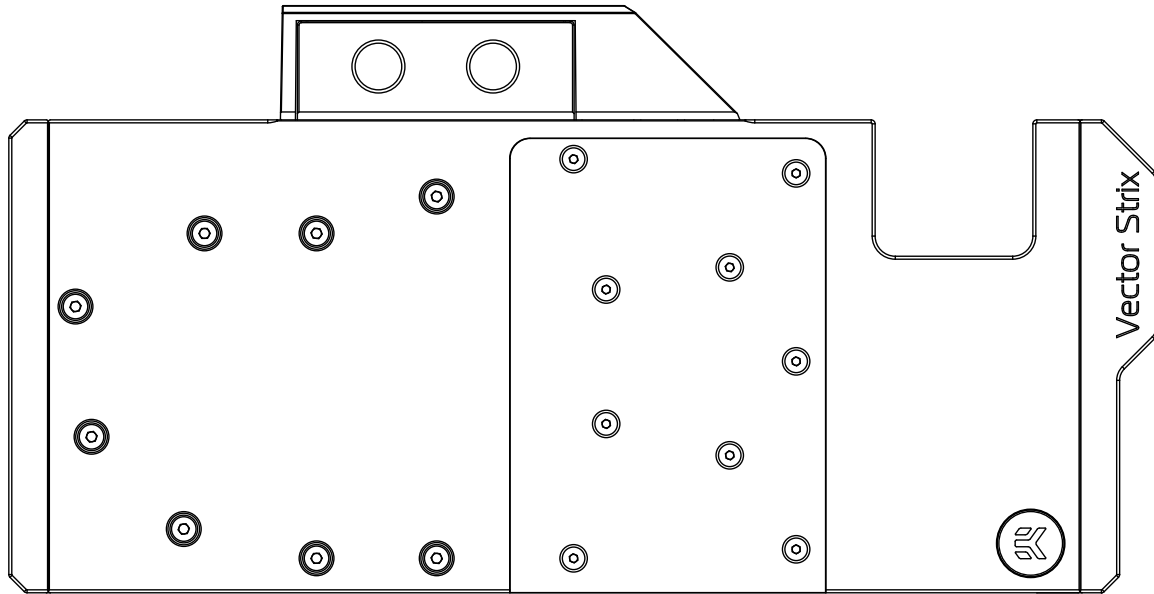

This product is compatible with AMD Radeon RX 5700 Strix graphics cards. It is intended for installation only by expert users. Please consult with a qualified technician for installation. Improper installation may result in damage to your equipment. EK Water Blocks assumes no liability whatsoever, expressed or implied, for the use of these products, nor their installation. The following instructions are subject to change without notice. Please visit our web site at www.ekwb.com for updates. Before installation of this product please read important notice, disclosure and warranty conditions printed on the back of the box.

Before you start using this product please follow these basic guidelines:

Please carefully read the manual before beginning with the installation process!

Please remove your graphics card from the computer to assure safest mounting process in order to prevent any possible damages to your GPU and/or graphics card circuit board (PCB).

The EK Fittings require only a small amount of force to screw them firmly in place since the liquid seal is ensured by the rubber O-ring gaskets.

The use of corrosion inhibiting coolants is always recommended for liquid cooling systems, and mandatory for nickel plated water blocks!

Do not use pure distilled water! For best results EK recommends the use of EK-CryoFuel coolants!

Make sure to thoroughly bleed air out of your water block, or you will not reach optimal performance!

TABLE OF CONTENT

PREPARING YOUR GRAPHICS CARD	4
INSTALLING THE WATER BLOCK	7
CHECKING FOR CONTACTS	8
INSERTING THE CARD IN YOUR PC CASE	8
INSTALLATION OF FITTINGS AND TUBING	9
CONNECTING THE D-RGB LED STRIP	9
SUPPORT AND SERVICE	10
SOCIAL MEDIA	10

PREPARING YOUR GRAPHICS CARD

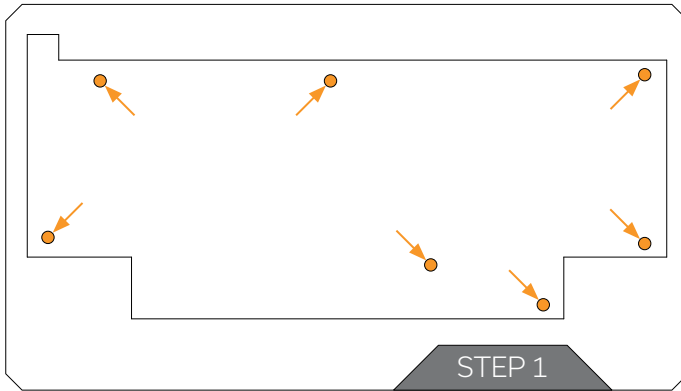

STEP 1

REMOVING THE FACTORY PROVIDED BACKPLATE

Remove seven (7) encircled screws using a Phillips head screwdriver, then take off the backplate.

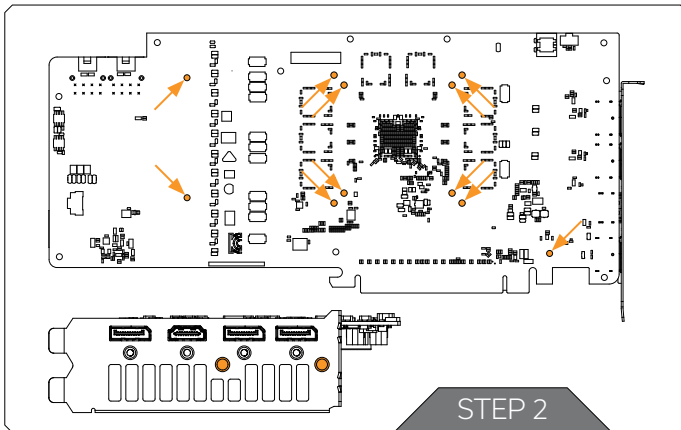

STEP 2

REMOVING THE STOCK COOLER

Remove the remaining screws as shown below. The cooler can now be gently removed, take care to unplug the LED and Fan connections. If there are any self-adhesive washers on either side of the PCB these should also be removed.

Remove two screws on the IO bracket using Phillips screwdriver

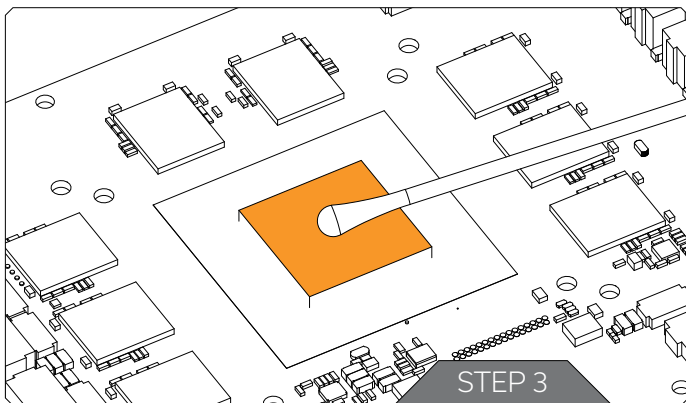

STEP 3 CLEANING THE PCB

Wipe off the remains of any thermal compound from the GPU core by using a non-abrasive cloth or q-tip. EKWB recommends the use of denatured alcohol for removing TIM leftovers. Additionally, remove all of the stock thermal pads from both sides of the PCB

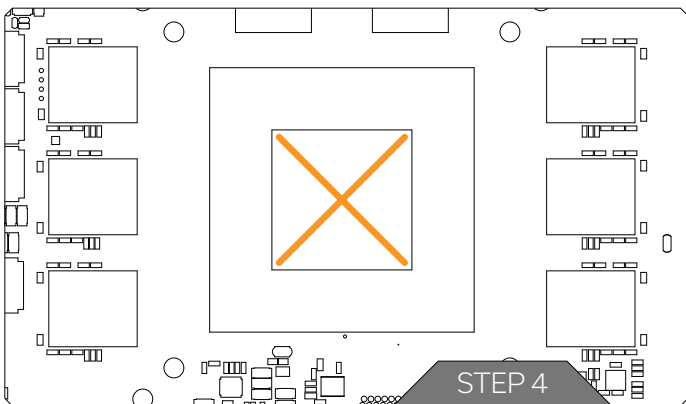

STEP 4 APPLYING THERMAL COMPOUND

Lightly cover AMD GPU chip with enclosed EK-TIM Ectotherm thermal grease. EKWB recommends to apply the thermal grease in a cross form to best performance (see sample picture).

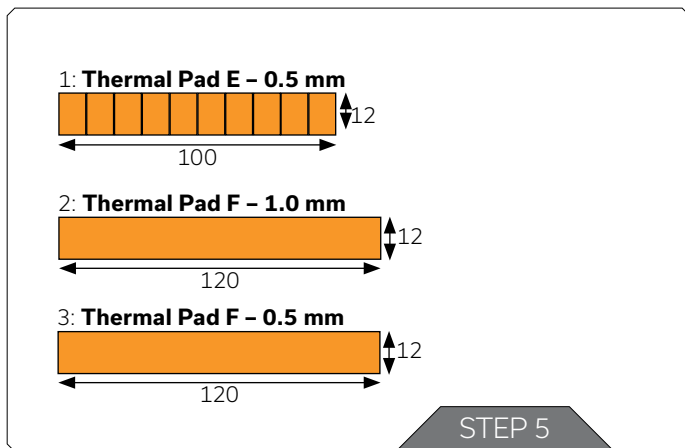

STEP 5 CUTTING THERMAL PADS

Your block is supplied with thermal pads that need to be cut into smaller pieces in order to cover all VRM components.

PLEASE REMOVE THE PROTECTIVE FOIL FROM BOTH SIDES OF THE THERMAL PADS PRIOR TO INSTALLATION.

Replacement thermal pads:

3830046996688 - Thermal PAD E 0,5 mm - (RAM 8X)

3830046996732 - Thermal PAD F 1,0mm - (120 x 16 mm)

3830046996725 - Thermal PAD F 0,5 mm - (120 x 16 mm)

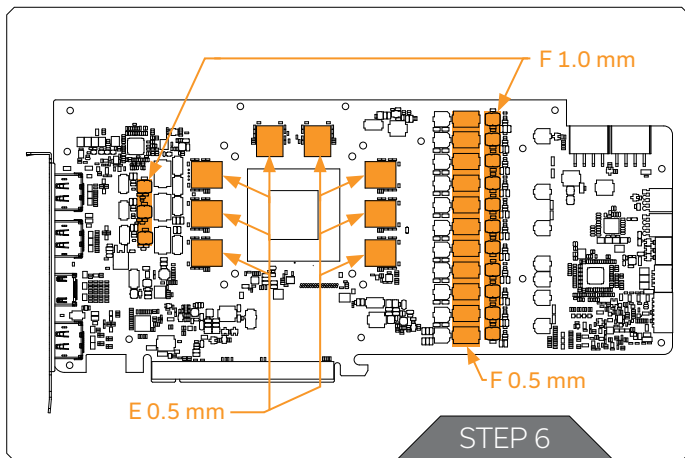

STEP 6 PLACING THERMAL PADS

Once cut to size the thermal pads should be applied to the PCB as illustrated below. EK made sure to provide customers with more than adequate quantity of thermal pads to complete this step.

INSTALLING THE WATER BLOCK

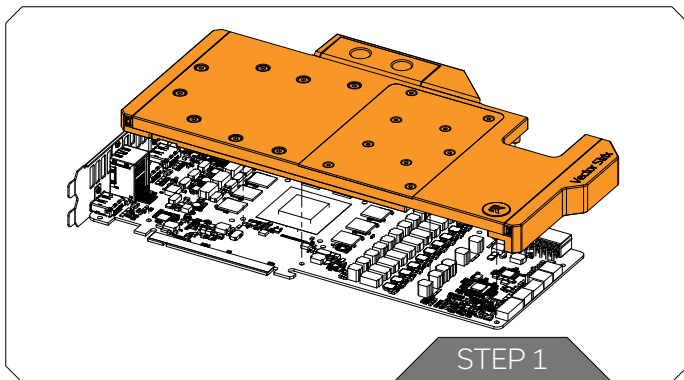

STEP 1

PLACING THE BLOCK ON TO THE GRAPHICS CARD

Carefully position the water block with preinstalled standoffs on to the graphics card. During this process please make sure you align mounting holes on the PCB with holes on the water block. Also pay attention not to use too much force by pressing the block down onto the PCB. Chip dies are prone to cracking. This procedure is the same for all Full Cover water blocks.

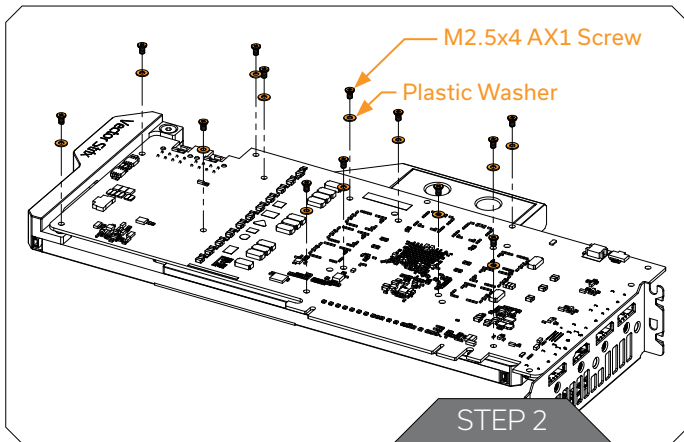

STEP 2

ATTACHING THE BLOCK TO THE GRAPHICS CARD

Use a Phillips head screwdriver with the enclosed M2,5 x 4 AX1 screws. EKWB recommends users to start tightening the screws evenly around the GPU core and then to continue outwards. Always use a plastic washer under every screw.

In this step you will need:

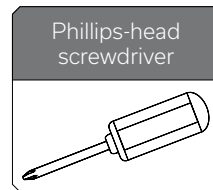

Phillips-head
screwdriver

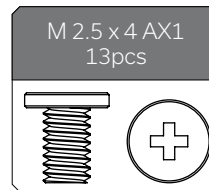

M 2.5 x 4 AX1
13pcs

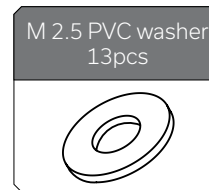

M 2.5 PVC washer
13pcs

CHECKING FOR CONTACTS

If necessary remove the water block to check for uniform surface contact between the block and the components, pay special attention to the VRM section of the graphics card. Check whether the water block makes contact with the intended integrated circuit. Then repeat sub-steps in previous section to re-attach the block.

In case you fail to obtain good contact, please check again that your thermal pad thickness or contact our support service at: <http://www.ekwb.com/support>.

INSERTING THE CARD IN YOUR PC CASE

Carefully lift your graphics card with block installed and insert it into the correct PCIe expansion slot on your PC's motherboard (consult motherboard manual). Please consider that your graphics card might be heavier than it was with the stock cooler, so be very careful when handling it. Avoid excessive manipulation of the graphics card assembly which may damage your graphics card, motherboard or water block during installation.

INSTALLATION OF FITTINGS AND TUBING

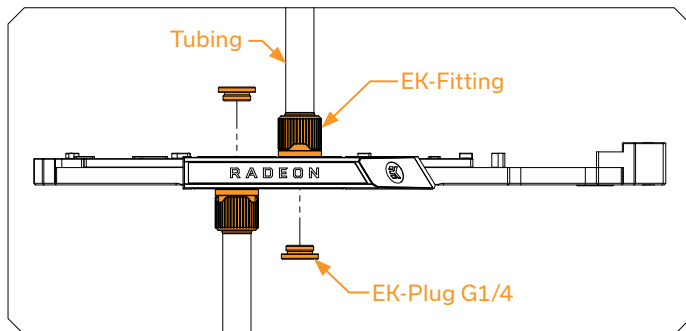

Screw in two male G1/4 threaded fittings. Attach the liquid cooling tubes and connect the water-block(s) into the cooling loop. **EKWB recommends using EK- fittings with the EK-Vector series water blocks.**

If you are using barb fittings please add hose clamps or an appropriate substitute to ensure that the tubes are firmly secured. You can configure any port as an inlet or outlet. Do not forget to plug all remaining ports with the enclosed EK-Plug G1/4 or equivalents.

CAUTION: If using fittings or plugs not recommending by EK take special care to check the length of the male G1/4 threads. 5 mm is the maximum allowed G1/4 thread length!

CONNECTING THE D-RGB LED STRIP

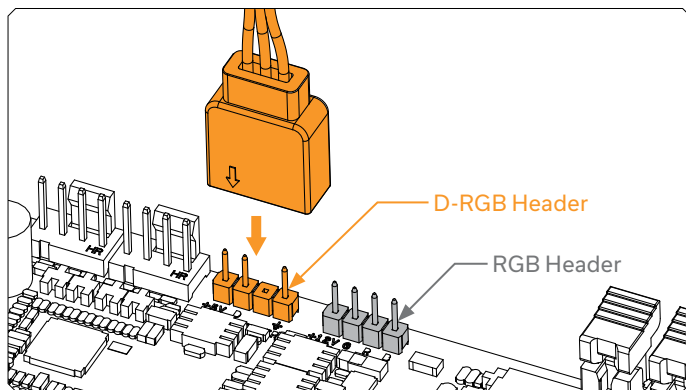

Plug the 3-pin connector from Water Block strip to the motherboard.



Please ensure that the arrow indicated on the connector is plugged into the +5V line as indicated on your motherboard. Failure to do so will damage your motherboard or LED strip.

SUPPORT AND SERVICE

For assistance please contact:

<http://support.ekwb.com/>

EKWB d.o.o.
Pod lipami 18
1218 Komenda
Slovenia - EU

SOCIAL MEDIA

 EKWaterBlocks

 @EKWaterBlocks

 ekwaterblocks

 EKWBofficial

 ekwaterblocks

