FreeAgent® GoFlex™ Home User Guide



FreeAgent® GoFlex™ Home User Guide

© 2010 Seagate Technology LLC. All rights reserved. Seagate, Seagate Technology, the Wave logo, and FreeAgent are trademarks or registered trademarks of Seagate Technology LLC, or one of its affiliates. All other trademarks or registered trademarks are the property of their respective owners. When referring to hard drive capacity, one gigabyte, or GB, equals one billion bytes and one terabyte, or TB, equals one thousand billion bytes when referring to hard drive capacity. In addition, some of the listed capacity is used for formatting and other functions, and thus will not be available for data storage. Quantitative usage examples for various applications are for illustrative purposes. Actual quantities will vary based on various factors including file size, file format, features, and application software. Seagate reserves the right to change, without notice, product offerings or specifications.

Seagate Technology LLC
920 Disc Drive
Scotts Valley CA 95066 U.S.A.

Contents

1. Introduction	5
About This Guide	5
System Requirements	5
Getting to Know GoFlex Home	6
Special Features of GoFlex Home	7
2. Setting Up GoFlex Home – Windows	9
Step 1: Familiarizing Yourself with the Setup Process	9
Step 2: Connecting GoFlex Home	10
Step 3: Installing the Software	12
Step 4: Setting Up GoFlex Home	12
Step 5: Adding a User to GoFlex Home	15
Step 6: Adding PCs to GoFlex Home	17
Next Steps	18
3. Setting Up GoFlex Home – Mac	19
Step 1: Familiarizing Yourself with the Setup Process	19
Step 2: Connecting GoFlex Home	20
Step 3: Setting Up GoFlex Home	20
Step 4: Installing GoFlex Home Desktop Applications	23
Step 5: Configuring Time Machine for GoFlex Home	24
Step 6: Setting Up More Mac Computers	26
Next Steps	27
4. Getting Started with GoFlex Home	28
Opening the Seagate Dashboard	28
Opening Seagate Share	31
Getting to Know Your GoFlex Home Folders	36
Copying Your Files to GoFlex Home	37
Backing Up Your Files to GoFlex Home	39
Accessing and Enjoying Your Files on Your Home Network	40

Accessing and Enjoying Your Files When You're Away from Home	43
Sharing Your Files with Friends and Family	43
Setting Up a Centralized Printer	47
Enjoying Your Files on a Digital Video Player or Game Console	48
5. Enjoying and Managing Your Files in Seagate Share	50
Playing Music	50
Playing Movies and Videos	51
Enjoying Your Photos	51
Managing Files and Folders	53
Managing Your Shares	56
Accessing Your GoFlex Home Files Using FTP	61
6. Managing GoFlex Home	62
Changing Your Own GoFlex Home Password	62
Customizing Your GoFlex Home User Settings	62
Adding New GoFlex Applications to Your Computer	63
Adding and Managing User Accounts	64
Managing GoFlex Home and Connected Devices	66
Adding More Storage Capacity to GoFlex Home	69
Managing GoFlex Home Settings and Preferences	69
7. Solving Problems	72
Common Problems and Solutions	72
Decoding the GoFlex Home Lights	74
Finding More Help	75

1. Introduction

The FreeAgent® GoFlex™ Home network storage system lets you use one external drive for all the computers in your home. With enough capacity to support multiple computers and users, you can easily store all of your files in one centralized location, while automatically and continuously backing up the files and folders on every computer in your home.

Setup is as simple as connecting to your Wi-Fi router, and in just minutes, you can begin wirelessly accessing files and streaming photos, music and movies to personal computers (PCs), Mac® computers, and game consoles. Plus, you can share a printer with every computer in the home by simply connecting it to the USB port on GoFlex Home.

About This Guide

This *User Guide* introduces the features of GoFlex Home, describes how to set up your GoFlex Home network storage system, and explains how to use GoFlex Home to share and store your files, back up your files, and access your files from anywhere in the world.

This *User Guide* also provides detailed instructions for using Seagate Share, a Web-based application that allows you to access your files on GoFlex Home over the Internet, as well as share files with friends and family.

Note: Some of the features described in this *User Guide* are available only on computers running the Windows operating system. Sections of the guide that describe Windows-only features are clearly marked.

System Requirements

To set up and use GoFlex Home, you need:

- Home network (also called a Local Area Network, or LAN)
- Wired or wireless router with an available Ethernet port
- Internet connection for file sharing over the Web

PCs accessing GoFlex Home require:

- Pentium III 500 MHz-equivalent processor or higher
- 256 MB RAM
- Windows® XP, Windows Vista®, or Windows 7 operating system
- Internet Explorer® 6 or later, Firefox® 2.x or later, or Chrome 4.x or later Web browser

Mac computers accessing GoFlex Home require:

- Mac OS® X 10.4 or later operating system
- Safari® 3.1 or later Web browser

GoFlex Home works with most consumer home network equipment with no special settings required. However, if you have a business-grade router in your home, you may need to adjust its network settings.

Getting to Know GoFlex Home

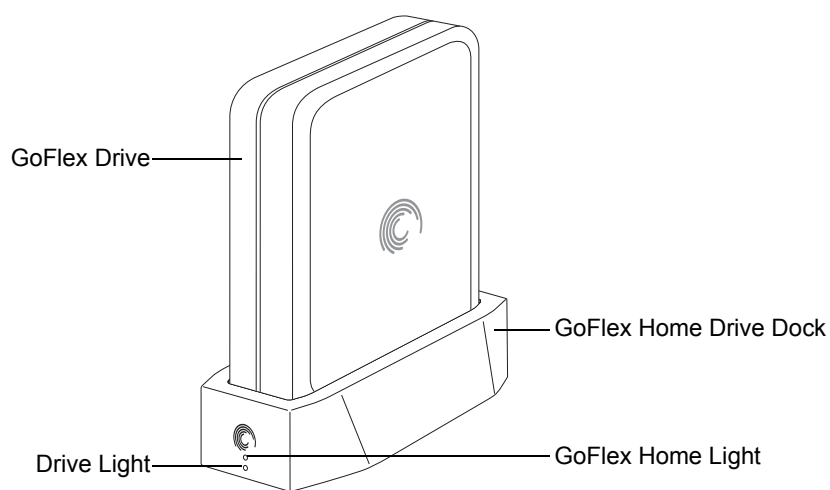

Figure 1: GoFlex Home Front

- **GoFlex Home Drive Dock:** Compatible with any FreeAgent GoFlex Home or Go Flex Desk drives
- **GoFlex Home Drive:** Provides 1 TB or 2 TB of storage space (depending on your model)
- **GoFlex Home Light:** Provides information about GoFlex Home's current state:
 - **Green blinking:** GoFlex Home is starting up.
 - **Green steady:** GoFlex Home is connected to the network and ready for use.
 - **Amber blinking:** GoFlex Home is not connected to the network.
- **Drive Light:** Provides information about the drive's current state:
 - **White steady:** GoFlex drive is installed in dock and ready for use.
 - **White off:** GoFlex drive is not installed or is experiencing a problem.

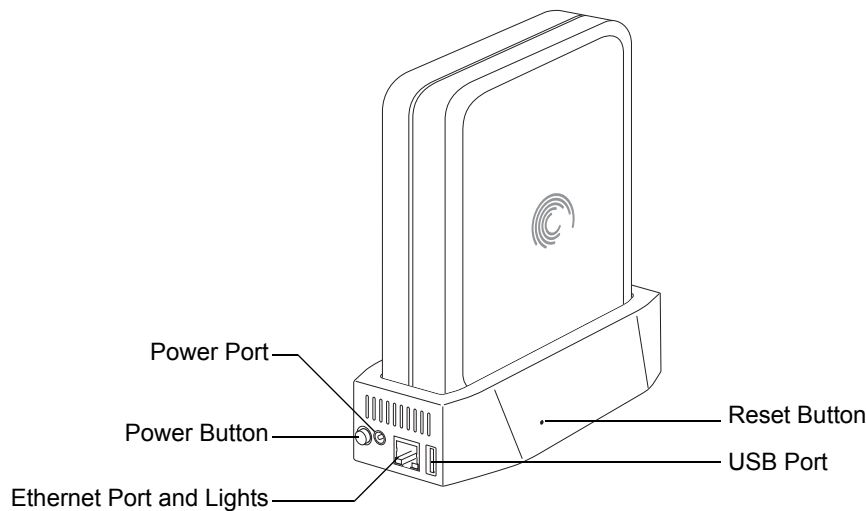

Figure 2: GoFlex Home Back

- **Power Button:** Turns GoFlex Home on and off.
- **Power Port:** Connects GoFlex Home to a power source.
- **Ethernet Port:** Connects GoFlex Home to your router.
 - **Ethernet Port Lights:** Indicate network activity when blinking.
- **USB Port:** Connects GoFlex Home to any USB storage device, such as a drive or printer.
- **Reset Button:** Resets the GoFlex Home password; resets GoFlex Home to its original factory settings (normally not necessary—see page 68 for more information).

Special Features of GoFlex Home

- **Instant Backup:** GoFlex Home protects your important files with automatic, “set it and forget it” file backup using Memeo™ Instant Backup (*Windows only*), and is also Time Machine®-compatible for Mac computers.
- **Centralized Storage:** GoFlex Home is a central location for storing digital media (music, photos, movies) and other household files you want to share with everyone on your home network. You can store Windows- and Mac-compatible files all in one place.
- **User Accounts:** Up to five people/computers on your home network can access GoFlex Home. (You can upgrade to unlimited accounts by subscribing to Seagate Share Pro. See page 8 for more information.)
- **Remote Access:** GoFlex Home provides access to your digital content from anywhere inside or outside your home, using the Web-based Seagate Share application. You can even access GoFlex Home from your smart phone (available with Seagate Share Pro—see page 8).

- **Centralized Printing:** If you connect a printer to the USB port on your GoFlex Home, everyone on your home network can wirelessly print from that one printer. See page 47 for more information.
- **Music and Video Streaming (DLNA):** Everyone on your home network can stream music, movies, and videos to their computer or to a digital media device, such as a FreeAgent GoFlex TV, from GoFlex Home. (*DLNA* stands for Digital Living Network Alliance, and is a technology that allows you to enjoy the digital media files stored on your GoFlex Home on a digital media device.)
- **Seagate Dashboard:** This software serves as a central location from which you can access all of GoFlex Home's features (*Windows only*).
- **Easy Expansion:** If you require additional storage capacity in the future, you can easily remove and replace the drive in GoFlex Home—no tools required. You can also connect an external USB drive directly to GoFlex Home for even more storage space. See page 69 for more information.

About Seagate Share Pro

Unlimited user accounts and other handy features are available with an upgrade to Seagate Share Pro, which provides premium service options that are available by yearly subscription.

Seagate Share Pro includes:

- Access to GoFlex Home and Seagate Share for an unlimited number of people.
- Remote access to GoFlex Home from a smart phone, such as a Blackberry® or iPhone®, or from another portable entertainment device, such as an iPad.
- Integration with Facebook® and Flickr®, which lets you easily copy your GoFlex Home photos to your online accounts.
- The 3D wall interface by Cooliris, which enhances your enjoyment of your GoFlex Home photos.
- Secure remote access to GoFlex Home with FTPS.
- Integrated RSS (Really Simple Syndication) feeds, which make it effortless to keep friends and family updated with your latest shared files, such as vacation photos.

To learn more about these and other Seagate Share Pro features, click **Learn More** under Seagate Share Pro in the Seagate Dashboard Application Store.

About Premium Backup

If you would like to back up more than 3 PCs to your GoFlex Home, you can purchase a Premium Backup software upgrade from the Application Store on your Seagate Dashboard. Premium Backup software allows you to back up an unlimited number of PCs to your GoFlex Home.

2. Setting Up GoFlex Home – Windows

Setting up GoFlex Home is easy. This chapter explains each step and provides suggestions and options for getting the most out of GoFlex Home.

Step 1: Familiarizing Yourself with the Setup Process

Before you begin, familiarize yourself with the steps you'll follow while setting up GoFlex Home, and with the folders that GoFlex Home creates automatically for you during setup.

Main Setup Steps

- Connect GoFlex Home (as described in the printed *Quick Start Guide*).
- Name, activate, and register GoFlex Home.
- Install the software on your own computer:
 - Seagate Dashboard, for access to all GoFlex Home features
 - Memeo Instant Backup, for automatic file backups
- Create individual user accounts and passwords for everyone on your home network.
- Install the software on the other Windows computers on your home network (or set up Mac computers—see page 19).

See “Step 2: Connecting GoFlex Home” on page 10 for complete instructions.

Understanding GoFlex Home's Automatic Folder Creation

When you create your own user account and password during setup, GoFlex Home automatically creates three folders on the drive for you:

- A **Public** folder, where files can be stored and accessed by everyone on your home network.
- A **Personal** folder that only you can access, where you can store personal or private files that you don't want anyone else on your home network to see.
- A **Backup** folder that only you can access, where all your backup files are stored.

GoFlex Home also automatically creates Personal and Backup folders for each user account you create for the members of your household. Once setup is complete, each member of your household can upload their own digital media and other files to GoFlex Home by dragging and dropping files from their computers to the folders of their choice. For more information, see “Copying Your Files to GoFlex Home” on page 37.

Step 2: Connecting GoFlex Home

1. Unpack the box and ensure you have these items before continuing:

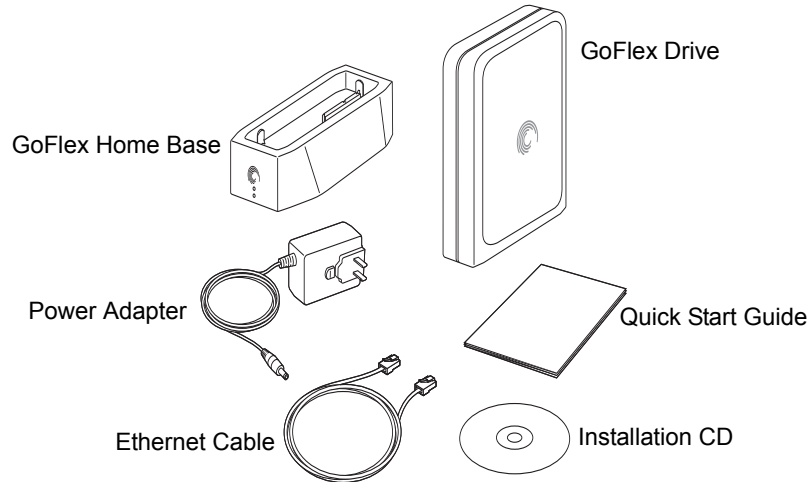

Figure 3: Package Contents

2. Ensure the Power button is in the Off position before you begin, then connect GoFlex Home:
 - a. Connect the supplied Ethernet cable to your router and to the Ethernet port on GoFlex Home.
 - b. Connect the supplied power adapter to a power outlet (DC 12V) and to the power port on GoFlex Home.

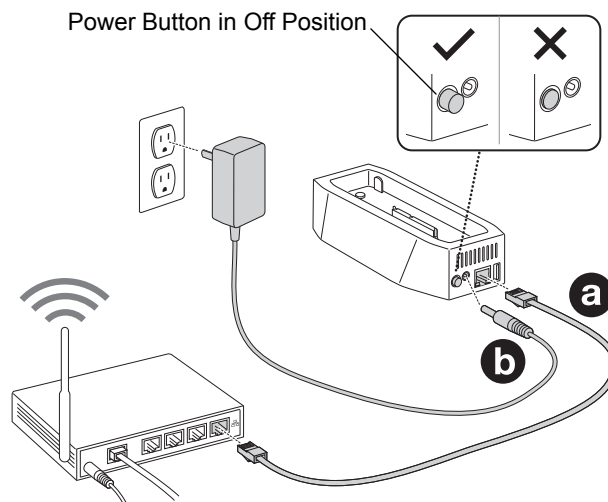

Figure 4: Connecting the Cables

3. Dock the drive into the base, then press the **Power** button.
 - a. Align the connector on the bottom of the drive with the connector in the base.
 - b. Gently press down on the drive until it clicks into place.
 - c. Press the **Power** button.

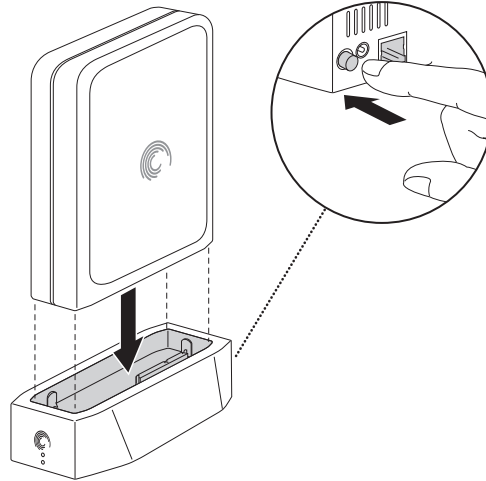

Figure 5: Docking the GoFlex Drive

4. Wait for the lights on the front of GoFlex Home to stop blinking. This may take a couple of minutes.

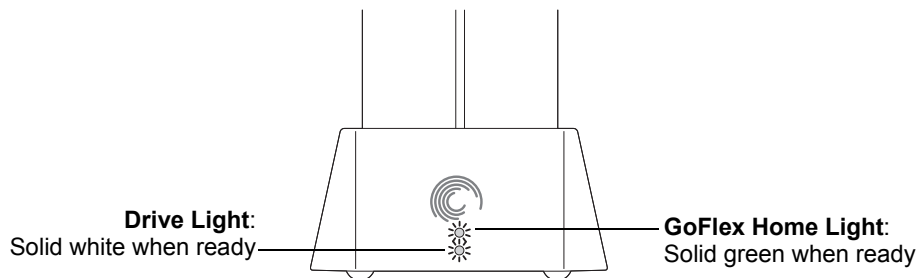

Figure 6: GoFlex Home Lights

If the GoFlex Home light is not solid green, wait about two minutes to make sure that GoFlex Home has had a chance to fully start up; if it's blinking amber, GoFlex Home either can't connect to the network or can't communicate with the drive. See "Solving Problems" on page 72 for more help.

Step 3: Installing the Software

1. Power on your computer, then insert the GoFlex Home Installation CD.

Note: If you are setting up GoFlex Home on a computer or device without a CD-ROM drive, go to www.seagate.com/goflexhomesupport to download the installation software.

2. When the Welcome screen opens, choose a language, then click **OK**.

A setup wizard opens.

TIP: If the Setup wizard doesn't open automatically, open Explorer, navigate to the CD, then double-click **SeagateDashboardSetup.exe**.

3. Follow the on-screen instructions to install the Seagate Dashboard and Memeo Instant Backup software applications.
4. When the installation is complete, click **Finish**, then continue with "Step 4: Setting Up GoFlex Home".

Step 4: Setting Up GoFlex Home

TIP: Before you continue, make sure you have a pen and paper handy to keep track of the names and passwords you need to create during setup.

When the software is installed, the GoFlex Home Setup wizard opens automatically. This may take a few moments.

The wizard finds and connects your computer to GoFlex Home, then the Device Information screen opens.

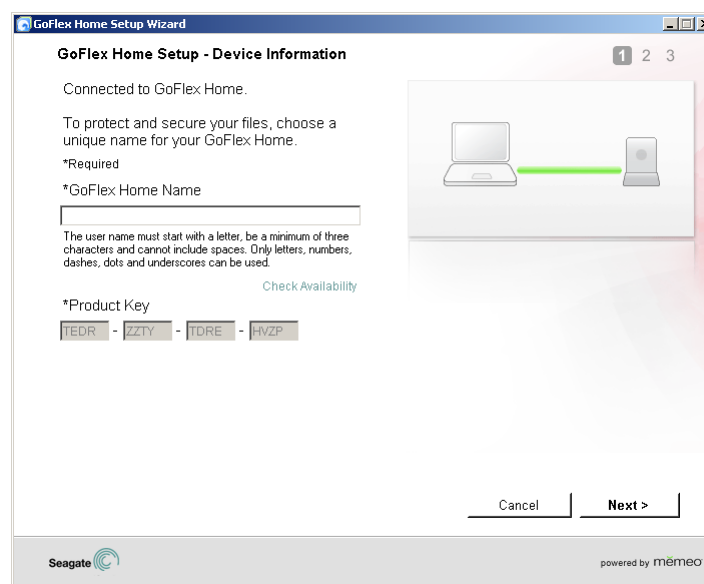

Figure 7: Adding Device Information

If your computer can't connect to GoFlex Home, see "Solving Problems" on page 72.

1. Enter a name for GoFlex Home.

The name must start with a letter and must be at least three characters in length. You can use letters, numbers, dashes, dots, and underscores. Spaces are not allowed.

Because you can access GoFlex Home over the Internet, the device must have a unique name. Use the **Check Availability** button to ensure the name you want is available.

If the Product Key hasn't been entered automatically, find it on the bottom of the GoFlex Home base and enter it in the Product Key boxes.

2. Click Next.

GoFlex Home is activated, and the Account Information screen opens.

Figure 8: Creating the First User Account

3. Create a user account for yourself by entering a user name and password. Passwords must be at least six characters long and must include one number. Passwords are case-sensitive.

Enter an e-mail address that can be used for occasional system messages. You will receive a system message if there is a problem with the drive, if the drive is full, or if your Seagate Share Pro subscription is expiring soon.

4. Click Next.

The Registration screen opens.

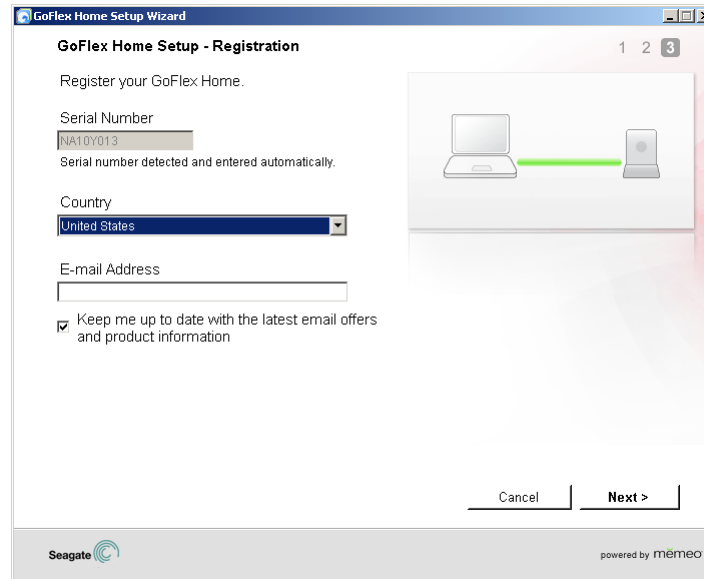

Figure 9: Registering GoFlex Home

5. Select your country and enter an e-mail address for registration purposes, then click **Next**. GoFlex Home is named, activated, and ready to use.

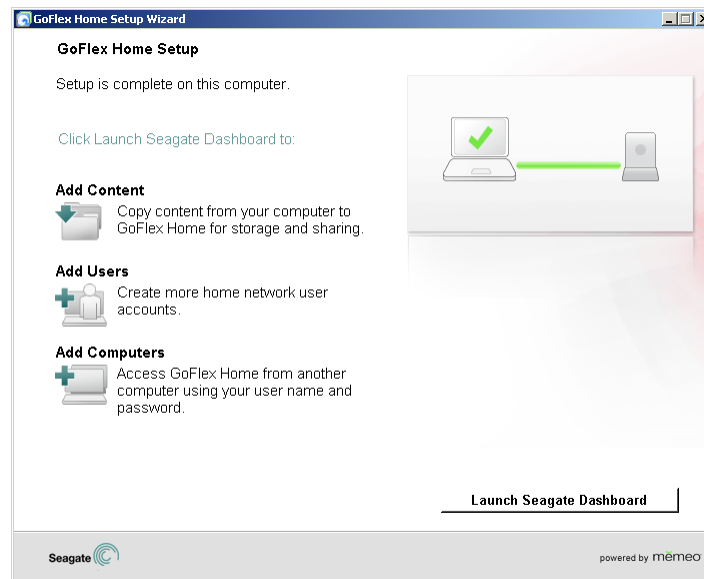

Figure 10: Setup Complete

6. Click **Launch Seagate Dashboard**.

The Seagate Dashboard opens.



Figure 11: Seagate Dashboard

The Seagate Dashboard is the central location from which you can access all of GoFlex Home's features. See page 28 for more information.

7. Continue setting up GoFlex Home for your household by adding user accounts for other members of your household (see page 15) and adding more computers to your GoFlex Home network storage system (see page 17).

Step 5: Adding a User to GoFlex Home

Everyone who needs access to GoFlex Home requires their own user account. Your GoFlex Home includes five user accounts.

TIP: You can upgrade to unlimited accounts (and add other useful GoFlex Home features) by subscribing to Seagate Share Pro. See "About Seagate Share Pro" on page 8 for more information.

To add new user accounts to GoFlex Home:

1. In the How to... panel of the Seagate Dashboard, click **Add Users**.

The Add Users window opens.

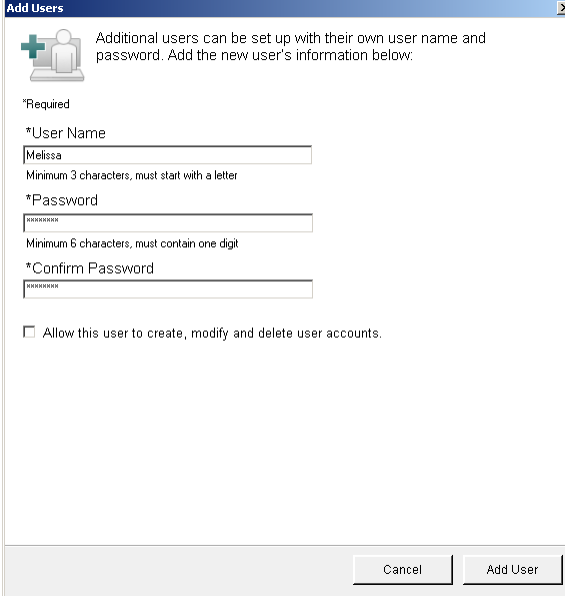

Figure 12: Creating Additional User Accounts

2. Enter a user name.

User names must start with a letter and must be at least three characters in length. User names are not case-sensitive. You can't use the same user name twice on GoFlex Home.

3. Enter and confirm a password for the user.

Passwords must be at least six characters long and must include one number. Passwords are case-sensitive.

TIP: When entering passwords, balance convenience and security appropriately for your household. For instance, you might have the members of your household choose their own passwords, but enter and keep track of them yourself so that you can act as the home network manager in case a password is forgotten or another issue arises. Or, you might have the members of your household enter their own passwords in private, so that only they can access the files they store in their Personal and Backup folders.

4. Select **Allow this user to create, modify, and delete user accounts** if you want this person to be able to do the same home network manager tasks as you.

5. Click **Add User**.

The user account is created, and the person can begin using GoFlex Home as soon as their computer is added to your GoFlex Home network storage system (see page 17).

6. Click **Add Another User** to continue creating user accounts (repeating the steps in this section), or click **Done**.

When you're done creating user accounts, continue with "Step 6: Adding PCs to GoFlex Home" on page 17.

Step 6: Adding PCs to GoFlex Home

Note: You can use both PC and Mac computers with GoFlex Home. See "Step 6: Setting Up More Mac Computers" on page 26 to add Macs to your GoFlex Home.

To add a PC to your GoFlex Home network storage system, you must install the GoFlex Home software—Seagate Dashboard and Memeo Instant Backup. Up to five people/computers on your home network can access GoFlex Home.

TIP: You can upgrade to unlimited users and computers (and add other useful GoFlex Home features) by subscribing to Seagate Share Pro. See "About Seagate Share Pro" on page 8 for more information.

To add a PC to GoFlex Home:

1. Power on the PC you want to add, then insert the GoFlex Home Installation CD.

Note: If you are setting up GoFlex Home on a computer or device without a CD-ROM drive, go to www.seagate.com/goflexhomesupport to download the installation software.

2. Follow the on-screen instructions to complete the installation.

When the software is installed, the GoFlex Home setup wizard opens automatically. When it finds and connects your computer to GoFlex Home, the Log-in screen opens.

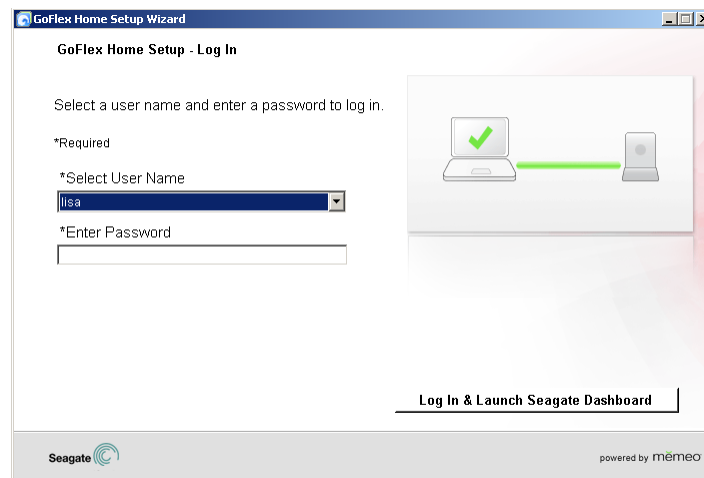

Figure 13: Adding Another Computer

3. Have the computer's regular user log in by choosing their user name and entering their password, then clicking **Log In & Launch Seagate Dashboard**. Remember that passwords are case-sensitive.
4. Repeat the steps in this section until you have added all the household PCs to your GoFlex Home network storage system (as required).

Your GoFlex Home network storage system is now fully set up and ready to use.

Next Steps

Now that GoFlex Home is set up, your next steps are to:

- Copy files from your computer to your GoFlex Home folders (see page 37).
- *(Optional)* Start automatic backups of the files on your computer (see page 39).
- Learn how to access and enjoy your files from home and while travelling (see page 40 and page 43).
- Share selected files with friends and family (see page 43).
- Set up a centralized printer (see page 47).

Pass along these chapters of the *User Guide* to each member of your household:

- "Getting Started with GoFlex Home" on page 28
- "Enjoying and Managing Your Files in Seagate Share" on page 50
- "Managing GoFlex Home" on page 62

Don't forget that you can add more user accounts and computers, enable access to GoFlex Home from smart phones, add other useful GoFlex Home features, or back up additional computers by subscribing to Seagate Share Pro or purchasing a Premium Backup software upgrade. See "About Seagate Share Pro" and "About Premium Backup" on page 8 for more information.

3. Setting Up GoFlex Home – Mac

Setting up GoFlex Home is easy. This chapter explains each step and provides suggestions and options for getting the most out of GoFlex Home.

Step 1: Familiarizing Yourself with the Setup Process

Before you begin, familiarize yourself with the steps you'll follow while setting up GoFlex Home, and with the folders that GoFlex Home creates automatically for you during setup.

Main Setup Steps

- Connect GoFlex Home (as described in the printed *Quick Start Guide*).
- Name, activate, and register GoFlex Home.
- Install the desktop applications on your own computer:
 - ComputersBackup
 - GoFlex Home Agent
 - SmartFolderShortcut (which allows you to access your files through Finder)
 - SmartWebShortcut (which opens the Seagate Share application in your browser)
- Configure Time Machine to use GoFlex Home as your file/system backup device.
- Install the desktop applications and configure Time Machine on the other Mac computers on your home network (or set up Windows computers—see page 9).

See “Step 2: Connecting GoFlex Home” on page 20 for complete instructions.

Understanding GoFlex Home’s Automatic Folder Creation

When you create your own user account and password during setup, GoFlex Home automatically creates three folders on the drive for you:

- A **Public** folder, where files can be stored and accessed by everyone on your home network.
- A **Personal** folder that only you can access, where you can store personal or private files that you don't want anyone else on your home network to see.
- A **Backup** folder that only you can access, where all your backup files are stored.

GoFlex Home also automatically creates Personal and Backup folders for each user account you create for the members of your household. Once setup is complete, each member of your household can upload their own digital media and other files to GoFlex Home by dragging and dropping files from their computers to the folders of their choice. For more information, see “Copying Your Files to GoFlex Home” on page 37.

Step 2: Connecting GoFlex Home

For instructions, see “Step 2: Connecting GoFlex Home” on page 10.

Step 3: Setting Up GoFlex Home

TIP: Before you begin, make sure you have a pen and paper handy to keep track of the names and passwords you need to create during setup.

1. Power on your computer, then insert the GoFlex Home Installation CD.

Note: If you are setting up GoFlex Home on a computer or device without a CD-ROM drive, go to www.seagate.com/goflexhomesupport to download the installation software.

2. Double-click the GoFlex Home Installation icon that appears on your desktop.

The Welcome screen opens.

3. Double-click **GoFlex Home Install** to begin the installation.

The main setup screen opens.



Figure 14: Main Setup Screen

4. Click **Step 1 Set Up Your GoFlex Home**.

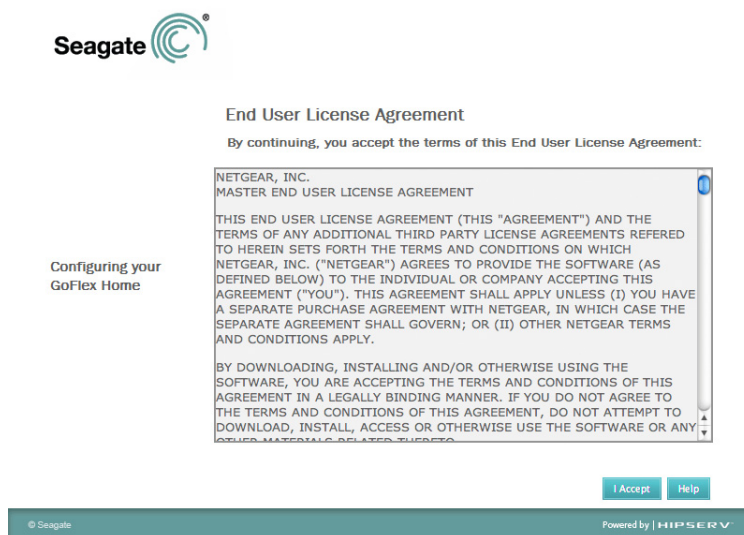

Figure 15: End User License Agreement

5. Read the End User License Agreement, then click **I Accept** to continue the setup.

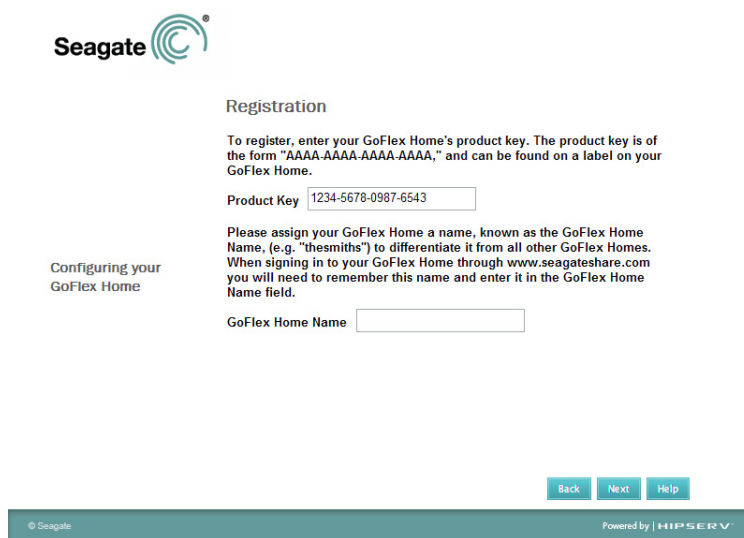

Figure 16: Naming and Registering GoFlex Home

6. Enter a name for GoFlex Home.

The name must start with a letter and must be at least three characters in length. You can use letters, numbers, dashes, dots, and underscores. Spaces are not allowed.

Because you can access GoFlex Home over the Internet, the device must have a unique name. If the name you enter is not available, you will be prompted to select a new name.

If the Product Key hasn't been entered automatically, find it on the bottom of the GoFlex Home base and enter it in the Product Key boxes.

7. Click **Next**.

Seagate

Administrator Account Creation

Enter a user name and password for your account. This account will be able to administer your GoFlex Home as well as being a user account.

Account

User Name: Your username is not case sensitive.

Password: Your password is case sensitive.

Confirm Password: Your password is case sensitive.

Back Next Help

© Seagate Powered by | HIPSERV

Figure 17: Creating the First User Account

8. Create a user account for yourself by entering a user name and password. The password must be at least six characters long and must include one number. Passwords are case-sensitive.
9. Click **Next**.

GoFlex Home is configured. (This may include an automatic software update.)

Seagate

Summary

LAN Connection: LAN IP Address: 192.168.0.110

Software Update

Here are the results of the software update.

Update Complete!

Your GoFlex Home's software has been updated to the latest available version. You may continue with the setup wizard by clicking Next below.

Back Next Help

© Seagate Powered by | HIPSERV

Figure 18: Configuring and Updating GoFlex Home

10. Click **Next**.

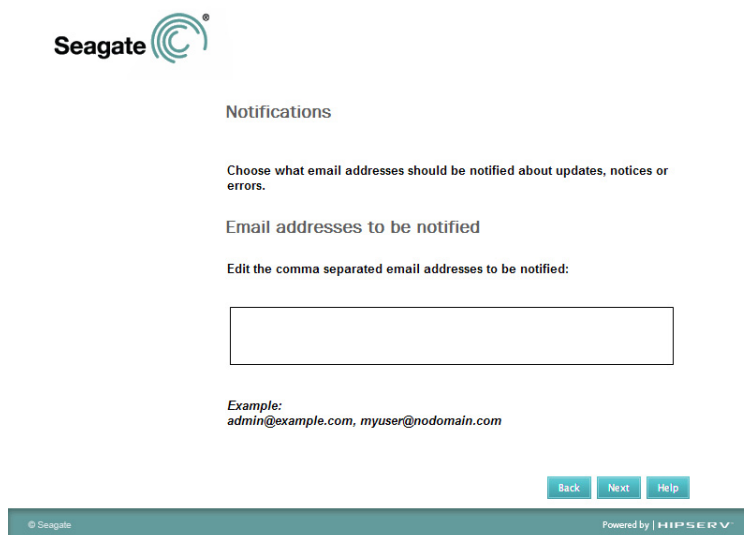

Seagate

Notifications

Choose what email addresses should be notified about updates, notices or errors.

Email addresses to be notified

Edit the comma separated email addresses to be notified:

Example:
admin@example.com, myuser@nodomain.com

Back Next Help

© Seagate Powered by | HIPSERV

Figure 19: Entering an E-mail Address

11. Enter an e-mail address that can be used for occasional system messages. You will receive a system message if there is a problem with the drive, if the drive is full, or if your Seagate Share Pro subscription is expiring soon.

12. Click **Next**.

Your GoFlex Home device is now set up.

13. Click **Finish**.

The main setup screen opens again. Continue by installing the desktop applications that let you access GoFlex Home from your computer.

Step 4: Installing GoFlex Home Desktop Applications

In this step, you install these applications:

- ComputersBackup
- GoFlex Home Agent
- SmartFolderShortcut
- SmartWebShortcut

To install the desktop applications:

1. On the main setup screen, click **Step 2 Install Desktop Applications (Optional)**.

The Welcome screen opens.

2. Click **Continue**.

3. Click **Install**.

If required, click **Change Install Location...**, adjust the settings, then click **Install**.

4. When the installation is complete, click **Close**.

The main setup screen opens again. Continue by configuring Time Machine to use GoFlex Home as your file backup device.

Step 5: Configuring Time Machine for GoFlex Home

TIP: If you don't want to use Time Machine backup software with GoFlex Home, you can use a complimentary Mac version of Memeo Instant Backup provided in a stand-alone folder on the GoFlex Home Installation CD.

If you are setting up GoFlex Home on a computer or device without a CD-ROM drive, go to www.seagate.com/goflexhomesupport to download the installation software.

To configure Time Machine so that it backs up your important files to GoFlex Home:

1. On the main setup screen, click **Step 3 Windows/Time Machine Backup Configuration (Optional)**.

The Welcome screen opens.

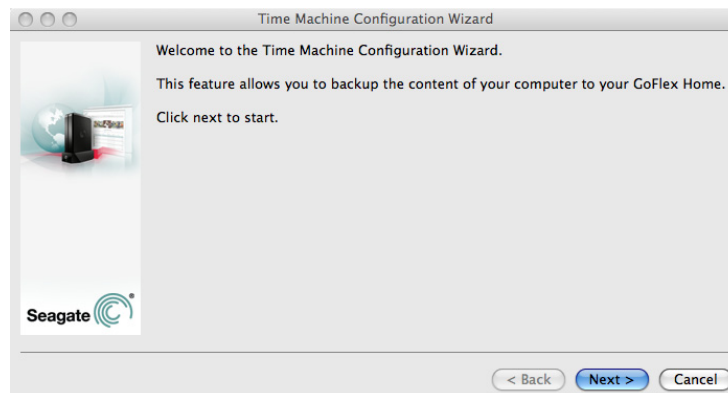

Figure 20: Welcome Screen

2. Click **Next**.

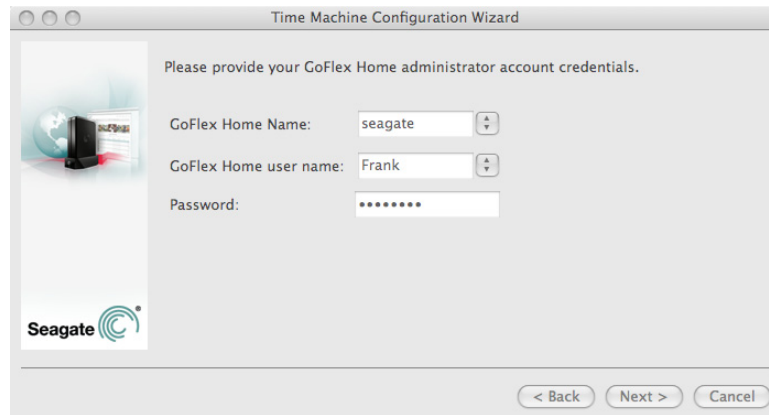

Figure 21: Logging in to GoFlex Home

3. Enter the name you gave to GoFlex Home (see page 21), your user name, and your password, then click **Next**.

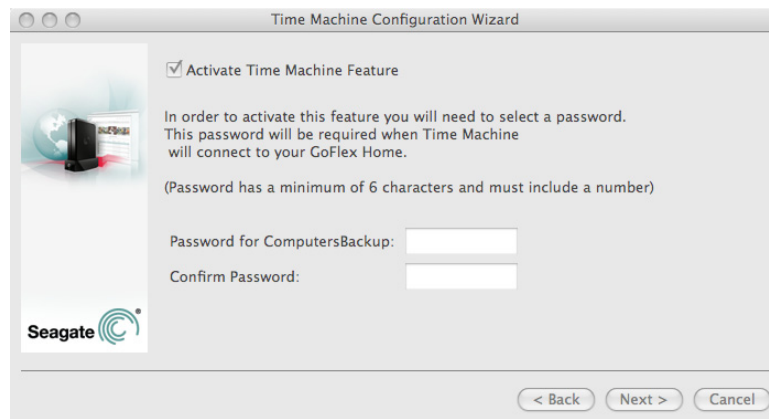

Figure 22: Creating a Password

4. Create a password to use when connecting Time Machine to GoFlex Home. The password must be at least six characters long and must include one number. Passwords are case-sensitive.
5. Click **Next**. When prompted, click **Next** again to launch the Time Machine Configuration tool.
6. If you previously set up Time Machine to back up your files to another location, you are prompted to replace your current configuration with GoFlex Home. Click **Yes** to continue the setup. (Click **No**, then skip to Step 8 if you wish to retain your current backup solution).

The Time Machine Walkthrough screen opens.

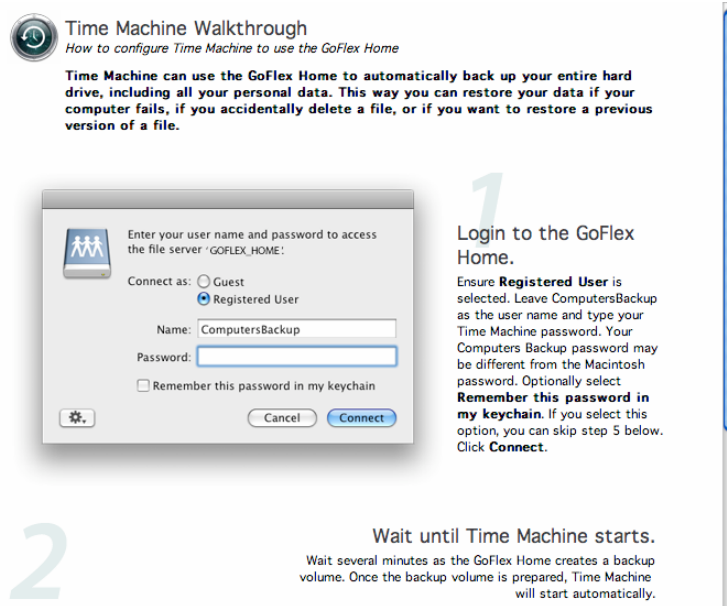

Figure 23: Logging in to GoFlex Home

7. Follow the on-screen instructions to configure Time Machine to use GoFlex Home as your backup device.
8. When you're finished, on the main setup screen, click **Exit** and remove the GoFlex Home Installation CD from your computer. Setup is complete on this computer.

Step 6: Setting Up More Mac Computers

Now that your GoFlex Home device is set up and you've created a user account for yourself, set up additional household computers (as required) to access your GoFlex Home network storage system.

Note: You can use both PC and Mac computers with GoFlex Home. See "Step 6: Adding PCs to GoFlex Home" on page 17 to add PCs to your GoFlex Home.

To set up another Mac computer:

1. Power on the computer and insert the GoFlex Home Installation CD.

Note: If you are setting up GoFlex Home on a computer or device without a CD-ROM drive, go to www.seagate.com/goflexhomesupport to download the installation software.

The Welcome screen opens.

2. Double-click the **GoFlex Home Installation** icon that appears on your desktop.

3. Double-click **GoFlex Home Setup** to begin the installation.

The main setup screen opens.

4. Click **Step 2 Install Desktop Applications (Optional)**, then follow the steps in “Step 4: Installing GoFlex Home Desktop Applications” on page 23.

5. When the installation is complete and the main setup screen re-opens, click **Step 3 Windows/Time Machine Backup Configuration (Optional)**, then follow the steps in “Step 5: Configuring Time Machine for GoFlex Home” on page 24.

6. Repeat the steps in this section until you have added all the household Mac computers to your GoFlex Home network storage system (as required).

Your GoFlex Home network storage system is now fully set up and ready to use.

Next Steps

Now that GoFlex Home is set up, your next steps are to:

- Copy files from your computer to your GoFlex Home folders (see page 37).
- Learn how to access and enjoy your files from home and while travelling (see page 40 and page 43).
- Share selected files with friends and family (see page 43).
- Set up a centralized printer (see page 47).

Pass along these chapters of this *User Guide* to each member of your household:

- “Getting Started with GoFlex Home” on page 28
- “Enjoying and Managing Your Files in Seagate Share” on page 50
- “Managing GoFlex Home” on page 62

Don't forget that you can add more user accounts and computers, enable access to GoFlex Home from smart phones, add other useful GoFlex Home features, or back up additional computers by subscribing to Seagate Share Pro or purchasing a Premium Backup software upgrade. See “About Seagate Share Pro” and “About Premium Backup” on page 8 for more information.

4. Getting Started with GoFlex Home

Now that GoFlex Home is set up, everyone in your household can begin sharing digital media and other files, storing files on GoFlex Home and accessing them from anywhere on the Internet, and backing up the files on their computers to GoFlex Home.

This chapter introduces the Seagate Dashboard and Seagate Share, the two applications you use to access and manage GoFlex Home. It explains how to copy files from your computer to your GoFlex Home folders, describes how to access your files when you're home or away from home, and provides getting-started tips for enjoying other popular GoFlex Home features.

Opening the Seagate Dashboard

The Seagate Dashboard is the central location from which you can access all the features of GoFlex Home. The Dashboard software is installed on Windows computers during setup.

Note: The Seagate Dashboard is available on Windows computers only. Mac users must use Seagate Share, the included Web-based application, to store, share, and access files on GoFlex Home. (See "Opening Seagate Share" on page 31 for more information.) Windows users can use either application.

You can open the Seagate Dashboard three ways:

- Double-click the Seagate Dashboard icon on your desktop.



Figure 24: Desktop Icon

- Double-click the Seagate Dashboard system tray icon on your desktop.

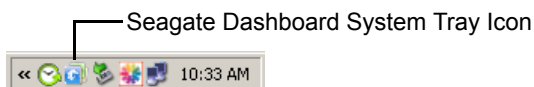

Figure 25: System Tray Icon.

- From the list of programs on the **Start** menu, select **Seagate Dashboard > Seagate Dashboard**.

The Seagate Dashboard opens.

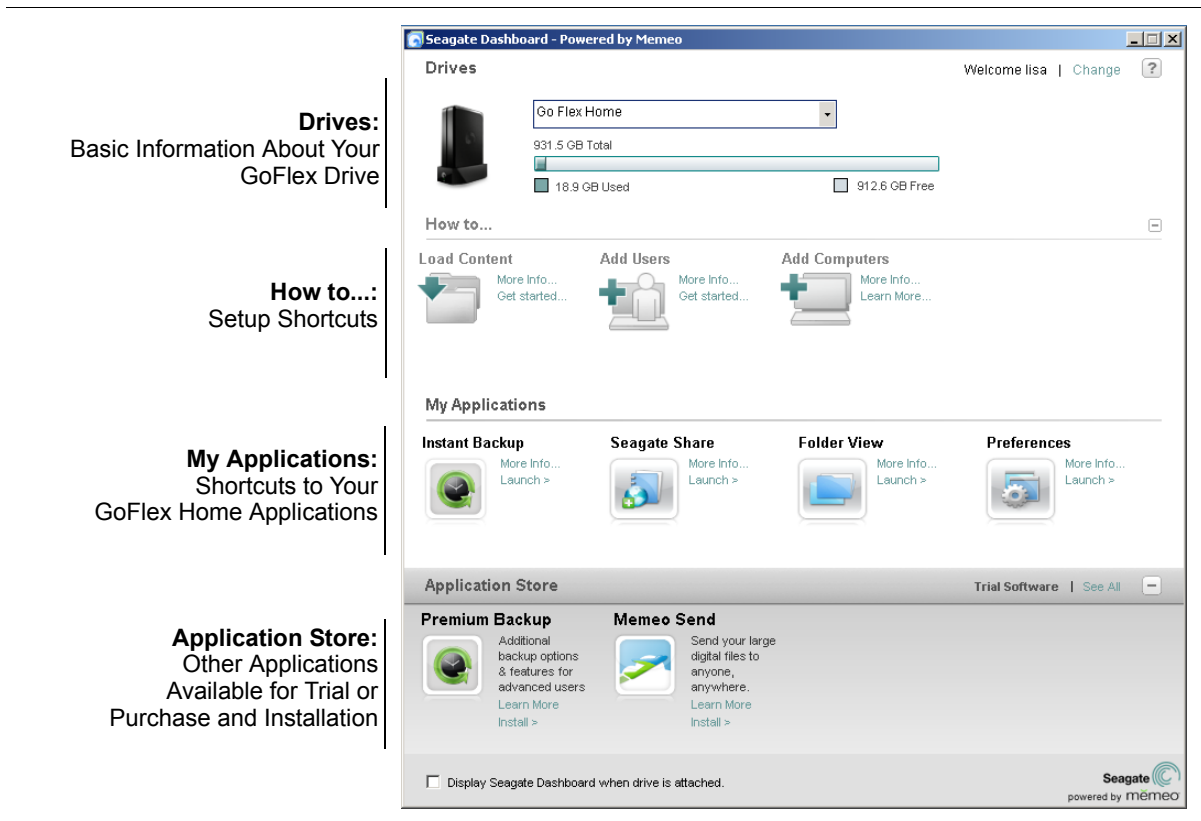

Figure 26: Seagate Dashboard

Navigating the Seagate Dashboard

The Seagate Dashboard has four main panels:

- **Drives panel**—The Drives panel shows the drive(s) connected to your computer and those found on your network. A capacity gauge of the drive's used and free space is also shown. Click the drop-down arrow to display other connected drives.
- **How to... panel**—Provides shortcuts to common setup tasks, and can be hidden by pressing the minus sign (-) once setup is complete.
- **My Applications panel**—Provides shortcuts to the GoFlex Home applications installed on your computer.
- **Application Store panel**—Lists other applications that are available for your computer, and provides links to trial versions.

Click the **Display Seagate Dashboard when drive is attached** box if you want the Dashboard to open automatically when you power on your computer.

Click ? (the online Help icon) in the top right corner to open the Seagate Dashboard online Help.

Click **Change** in the top right corner to change which user is logged in to the Dashboard (see page 30).

The Seagate Dashboard Features

From the Dashboard, you can:

- Copy content from your computer to GoFlex Home (see page 37).
- Share files in the GoFlex Home Public folder and access the files you've stored in GoFlex Home Personal (see page 40).
- Back up the files on your computer to GoFlex Home, using Memeo Instant Backup (see page 39).
- Share files with family and friends, using Seagate Share (see page 50).
- Change your GoFlex Home password (see page 62).
- Add new users to your GoFlex Home network storage system, and edit existing user accounts—permission required (see page 64).
- Manage your GoFlex Home network storage system—permission required (see page 62).
- Try new applications for free from the Application Store, or purchase and install new applications like Memeo Premium Backup (see page 63) or Seagate Share Pro (see page 8).
- Log in to GoFlex Home as a different user (see the next section).

Logging In to the Seagate Dashboard

You log in to the Seagate Dashboard for the first time during setup (see page 9), and you remain logged in even when you shut down your computer. You don't need to log in each time you open the Dashboard.

However, you can log in to the Dashboard from any computer that's connected to GoFlex Home, even if someone else is already logged in with their own account. By logging in as yourself, you gain access to your own GoFlex Home folders.

Note: Changing users on the Dashboard interrupts any file backup plan set up on the computer (see page 39). If you have logged in to the Dashboard on someone else's computer, allow them to log in again as soon as possible for their current backup plan to continue uninterrupted.

To log in to the Dashboard when someone else is already logged in:

1. Open the Seagate Dashboard on the computer (see page 28).
2. Click **Change** next to the user name on the top right of the Dashboard.

The Change User dialog box displays.

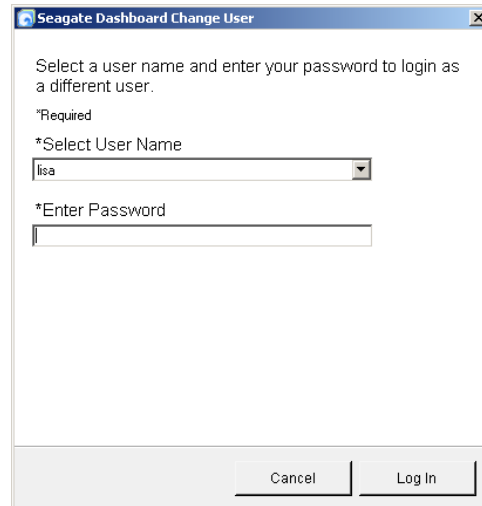

Figure 27: Seagate Dashboard: Changing Users

3. Select your user name, enter your password, then click **Log In**.

You are now logged in to the Dashboard.

Updating the Seagate Dashboard

To check for updated versions of the Seagate Dashboard:

1. Open the Seagate Dashboard (see page 28).
2. Click ? (the online Help icon) in the top right corner of the Dashboard, then select **Check for Updates**.

If a newer version of the Dashboard is available, follow the on-screen instructions to install it.

Opening Seagate Share

Seagate Share is a Web-based application that lets you access GoFlex Home even when you're not on your home network. If you have an Internet connection and a computer, you can use Seagate Share to watch movies, listen to music, view photos, or work with other files stored on GoFlex Home from anywhere in the world. You can also share your files with friends and family. (With Seagate Share Pro, you can even access GoFlex Home from your smart phone. See page 8 for more information.)

Seagate Share is not installed on your computer; it runs in your Web browser and provides many of the same features as the Seagate Dashboard. In Seagate Share, you can copy files from your computer to GoFlex Home, then access and work with them the same way you would if they were on your computer. You can also add and change user accounts, manage the GoFlex drive and any external USB drive connected to GoFlex Home, and change other GoFlex Home settings.

Mac users must use Seagate Share to access and manage GoFlex Home. Windows users can choose to use the Seagate Dashboard while they're on their home network, but must use Seagate Share to access GoFlex Home when they're not at home.

To open Seagate Share:

1. Open your Web browser, then navigate to *www.seagateshare.com*

OR

(Windows only) Open the Seagate Dashboard (see page 28), then click **Seagate Share**.

OR

(Mac only) Start Finder, browse to **Applications > GoFlex Home Desktop Applications**, and then launch **SmartWebShortcut**.

Seagate Share opens.

2. If prompted, enter the name of your GoFlex Home. (The name was created during setup. If you don't know the name, check with the person who set up your GoFlex Home.) Then, enter your user name and password.
3. (Optional) Select **Remember Me** so you don't have to re-enter your password the next time you log in.
4. Click **Sign In**.

TIP: If you open Seagate Share from the Dashboard or from SmartWebShortcut, you don't have to sign in.

The Seagate Share Home page opens. (This may take a few moments.)

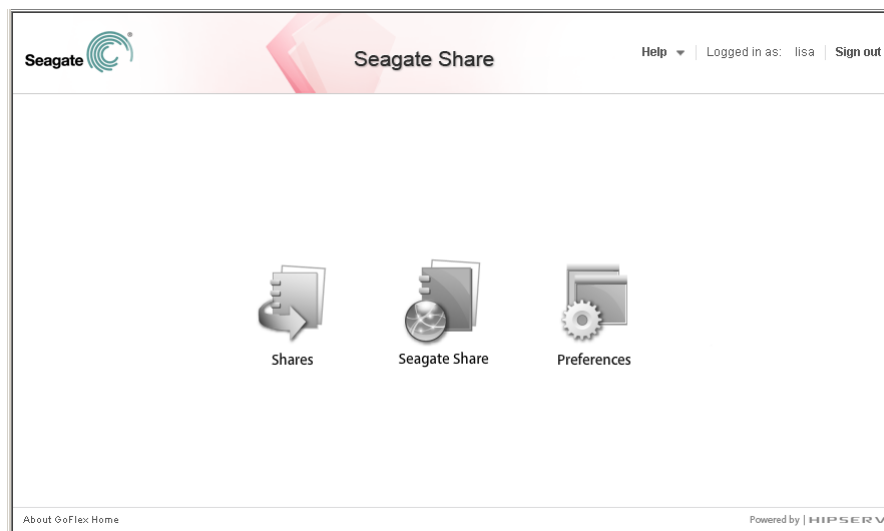

Figure 28: Seagate Share Home Page

5. Click **Seagate Share**.

The Seagate Share page opens.

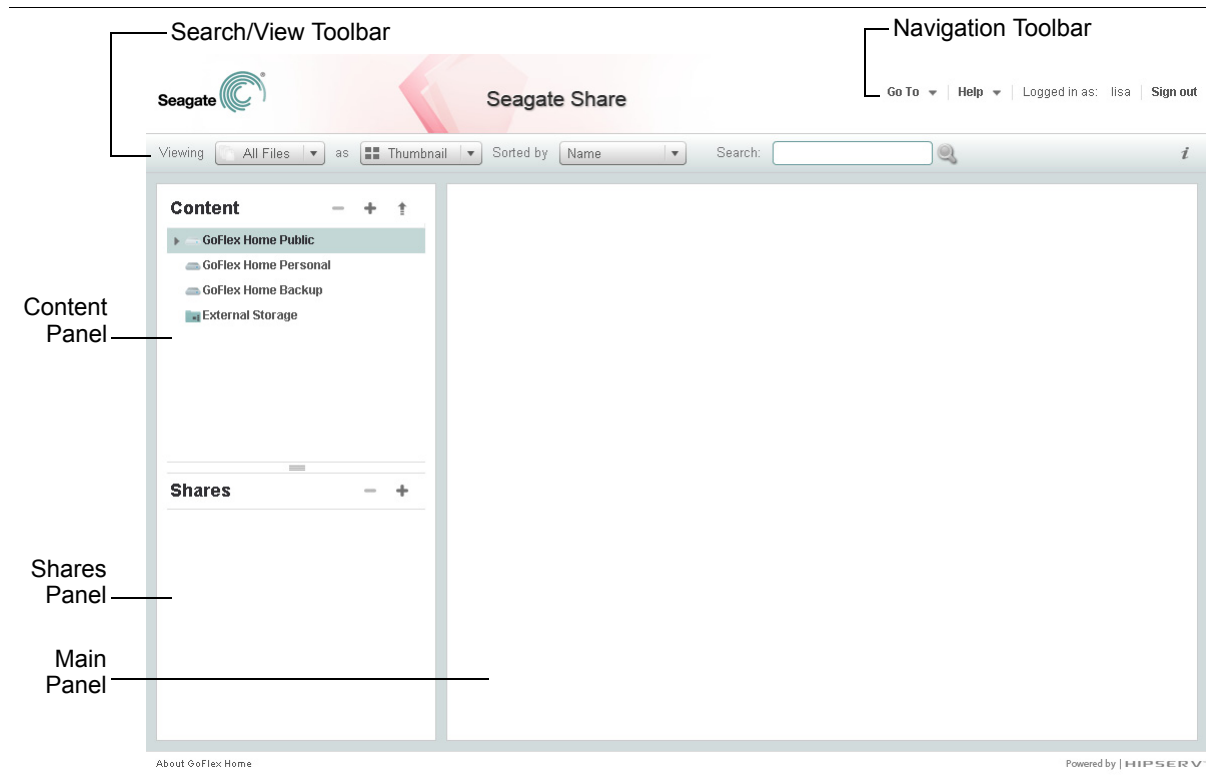

Figure 29: Seagate Share page

6. Click **OK** to close the Tip box, if necessary.

Navigating Seagate Share

The Seagate Share page has five sections:

- **Content panel:** Lists your three GoFlex Home folders. Any external USB drive connected to your GoFlex Home appears in the Content panel as an External Storage folder. You can use the plus (+), minus (-), and arrow (↑) buttons in the Content panel to add a folder, delete a folder, and upload new files to GoFlex Home.

Click on any folder in the Content panel to view its contents in the Main panel to the right.

- **Shares panel:** Lists your *shares*—collections of photos, music, movies, or other documents that you've assembled from the files in your GoFlex Home folders. You can create shares for your own enjoyment, or invite family and friends (or everyone on the Internet) to view them as well. You can use the plus (+) and minus (-) buttons in the Shares panel to add and delete shares.

Click on any share to view its contents in the Main panel to the right.

- **Main panel:** Displays the contents of folders and shares, when they're selected in one of the left-hand panels.

- **Search/View toolbar:** Provides drop-down menus that you can use to sort, filter, and search your files and folders, making it easy to find what you're looking for.

The Search/View toolbar also lets you choose how you want to view your files and folders (in a list or as thumbnails, for instance). Select **Shuffle** to rearrange files in a selected folder in random order; select **Cover** to see your files in a Windows filmstrip-type view. (*Seagate Share Pro users*—Select **Cooliris** to open photos in the 3D image viewing tool in the Cooliris application. See page 53 for more information.)

- **Navigation toolbar:** Includes the online Help menu, the Go To menu, and the sign-out feature. Use the Go To menu to move between the pages of Seagate Share:
 - Home page (the first page that appears when you open Seagate Share)
 - Shares page (which lists only your shares)
 - Seagate Share page
 - Preferences page (which lists all customizable settings for GoFlex Home—see page 69 for more information)

Completing Tasks Multiple Ways in Seagate Share

Seagate Share provides several ways of doing the same task. As you become familiar with Seagate Share, you'll find the method you're most comfortable with.

For instance, to move files to a share, you can:

- Drag and drop the files and folders into the share.
- Use the **Copy** and **Paste** options in the menu.
- Use the **Add to Share** menu option. (See "Finding the Seagate Share Menus" on page 35 for more information on menus.)

Finding the Seagate Share Menus

You can do most of the tasks you want to do on Seagate Share (such as starting a slideshow, adding a folder to a share, starting a movie, or downloading a file) from the menus that appear when you move your mouse over the file or folder you want, then click the arrow that appears.

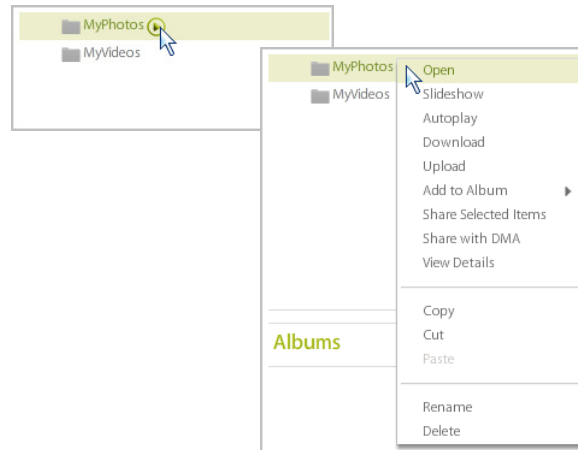

Figure 30: Finding the Menu

Seagate Share Features

From Seagate Share, you can:

- Copy content from your computer to GoFlex Home (see page 37).
- Access all the files in the GoFlex Home Public folder and the files you've stored in GoFlex Home Personal (see page 40).
- Collect photos, music, movies, or other documents from multiple folders to create *shares* that your family and friends can enjoy (see page 50).
- Select folders and files to share with digital media devices, such as a FreeAgent GoFlex TV (see page 48).
- Change your GoFlex Home password (see page 62) and customize other personal GoFlex Home settings (see page 62).
- Add and manage GoFlex Home user accounts—permission required (see page 64).
- Manage your GoFlex Home and connected devices (see page 66) and change the settings on your GoFlex Home device (see page 69).

Seagate Share Pro Features:

Seagate Share Pro is available by annual subscription, and includes these features:

- Share photos on Facebook (see page 45) and Flickr (see page 46).
- Share photos with everyone on the Internet and allow others to subscribe to your shares through RSS (Really Simple Syndication) feeds (see page 46).

- View photos in a 3D wall board using Cooliris (see page 53).

For more information about Seagate Share and Seagate Share Pro, see “Enjoying and Managing Your Files in Seagate Share” on page 50.

Getting to Know Your GoFlex Home Folders

Every member of your household has access to three folders on GoFlex Home:

- **GoFlex Home Public:** Folder where files can be shared with others on your home network. Use the Public folder to create a household media library of digital music, movies, videos, and photos (or other files) that everyone on your home network can access from their own computer.
- **GoFlex Home Personal:** Folder that only *you* can see and access, where you can store personal or private files. You can access files stored in your Personal folder from any computer or smart phone on the Internet, inside or outside your home, by logging in to GoFlex Home with your user name and password.
- **GoFlex Home Backup:** Folder that only *you* can see and access, where all your backup files are stored. See “Backing Up Your Files to GoFlex Home” on page 39 for more information.

When you open My Computer (Windows) or launch SmartFolderShortcut from Finder (Mac), your GoFlex Home folders are listed as three separate drives. GoFlex Home contains one Personal folder for every GoFlex Home user account; however, the only one you see is the one that matches your user name and password.

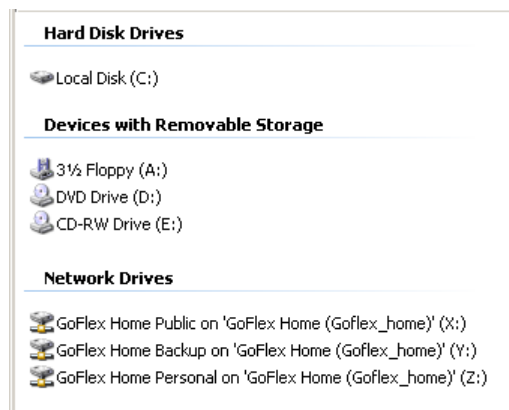

Figure 31: Your GoFlex Home Folders

Privacy Limitations

While the drive is docked in GoFlex Home, the contents of your Personal and Backup folders can be accessed only by you; however, the drive itself has no built-in access limitations. Keep in mind that the drive is removable and can be connected directly to any computer using a GoFlex Desk base while deciding whether to store financial or other private information on GoFlex Home.

Copying Your Files to GoFlex Home

Your first step with GoFlex Home is to copy (or *upload*) files from your computer to GoFlex Home. You can choose which files you want to upload, and choose whether to share those files with others on your home network or keep them private and viewable only by you.

Copying files to GoFlex Home does not delete them from your computer.

To access your files once they're stored on GoFlex Home, see "Accessing and Enjoying Your Files on Your Home Network" on page 40 and "Accessing and Enjoying Your Files When You're Away from Home" on page 43.

Copying Files to GoFlex Home Using the Seagate Dashboard

TIP: Mac users—You must use Seagate Share to copy files to GoFlex Home (see page 38).

To copy files from your computer to GoFlex Home:

1. Open the Seagate Dashboard (see page 28).
2. In the How to... panel, click **Load Content**.

The Load Content screen opens.

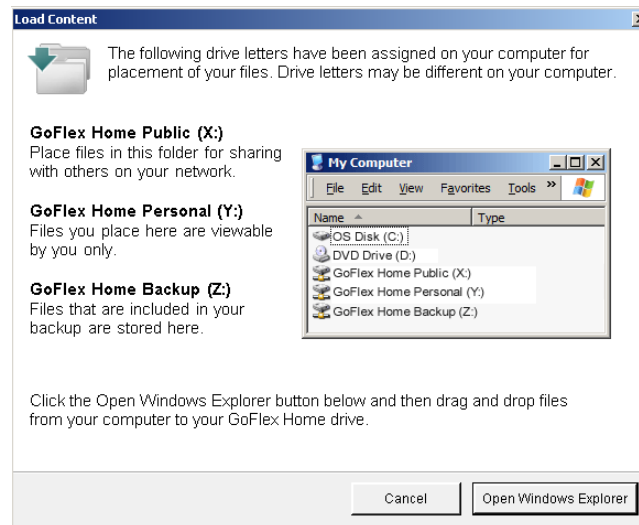

Figure 32: Load Content Screen

3. Click **Open Windows Explorer**.

Two Explorer windows open.

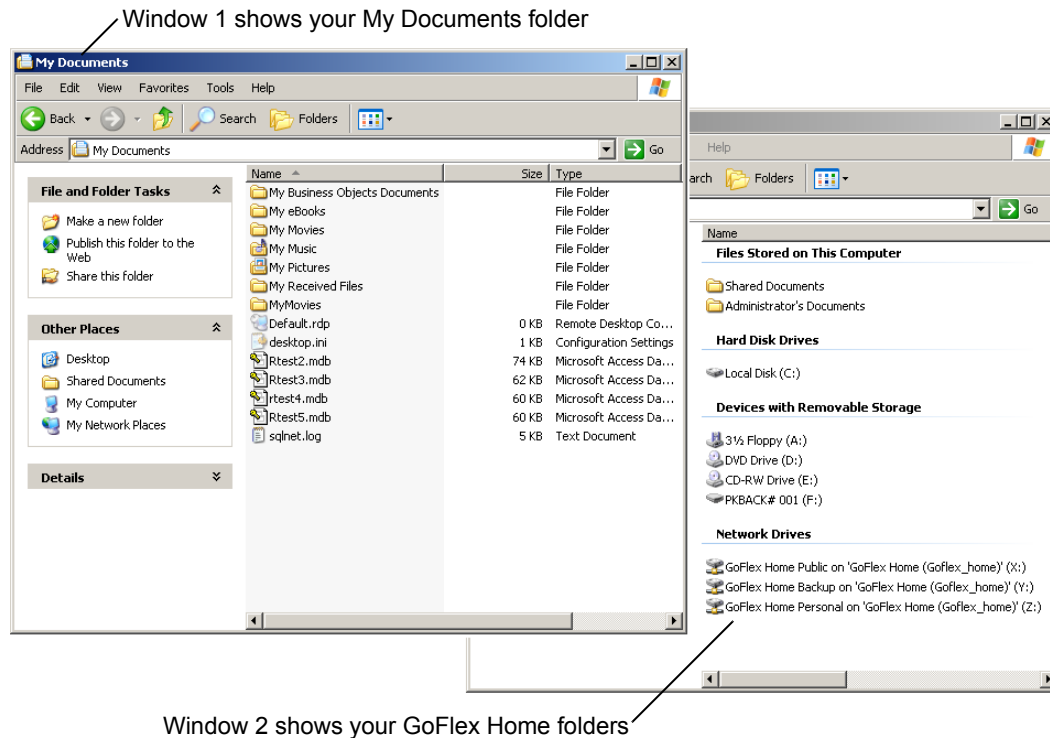

Figure 33: Copying Files to GoFlex Home

4. In the first window, select the folders and files you want to copy from My Documents. Drag and drop them into either the GoFlex Home Public or GoFlex Home Personal folder in the other window. (You can also copy files from other locations on your computer besides My Documents.)

The folders and files are copied to GoFlex Home. Depending on how big your files are, this may take a few moments to several minutes.

Copying Files to GoFlex Home Using Seagate Share

To copy files from your computer to GoFlex Home:

1. Open Seagate Share and log in (see page 31).
2. Click **Seagate Share**.

The Seagate Share window opens.

3. In the Content panel, select the folder where you want to copy your files, then click the up arrow (↑).

The Upload window opens.

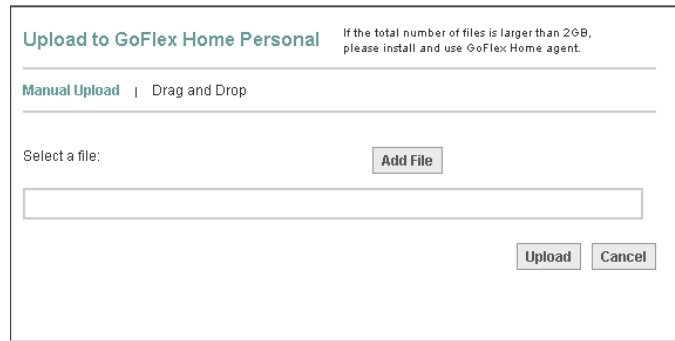

Figure 34: Seagate Share: Upload Window

4. *(Small number of files)* Click **Manual Upload**, click **Add File**, then browse to the file you want to upload. Repeat this step until all the files you want to copy are selected.

Or,

(Large number of files or folders) Click **Drag and Drop**. Open Finder or Windows Explorer, find the folders and files you want to copy, then drag and drop them into the Seagate Share Drag and Drop window.

TIP: The Drag and Drop feature requires Java Virtual Run Time Machine.

5. Click **Upload**.

The folders and files are copied to GoFlex Home. Depending on how big your files are, this may take a few moments to several minutes.

Backing Up Your Files to GoFlex Home

Note: The tasks described in this section can be done on Windows computers only.

Mac users—You can use Time Machine to back up your files to GoFlex Home. See “Step 5: Configuring Time Machine for GoFlex Home” on page 24 to get started. Refer to the Time Machine documentation on your computer for more information. If you don’t want to use Time Machine backup software with GoFlex Home, you can use a complimentary Mac version of Memeo Instant Backup provided in a stand-alone folder on the GoFlex Home Installation CD.

About Memeo Instant Backup

GoFlex Home includes Memeo Instant Backup software, a simple way to ensure your files are protected in case your computer is damaged, lost, or stolen. Once you start backups for your computer, Memeo Instant Backup automatically and continuously backs up every important file on your computer without any input from you.

GoFlex Home includes access to Memeo Instant Backup for up to three computers.

Starting Automatic Backups

To start automatic backups of your computer:

1. Open the Seagate Dashboard (see page 28).

Note: Install the latest version of Memeo Backup if you are prompted to update the software. This ensures that GoFlex Home has the latest features.

2. Click **Instant Backup**.

Memeo Instant Backup opens

Memeo Instant Backup automatically scans your computer's C drive and shows which files and folders will be backed up. You can change what will be backed up by clicking **Advanced Options**.

3. Ensure that your GoFlex Home Backup folder is selected from the drop-down menu.
4. Click **Start Backup**.

Memeo Instant Backup backs up your files. This may take some time, depending on how many files you have. If necessary, you can pause and restart the backup.

For additional information, refer to the Memeo Instant Backup Help. For more information about Memeo Instant Backup, click ? on the Seagate Dashboard to open the online Help.

On-going Backups

From now on, any new file you add to your computer, and any existing file that you edit and save, is backed up automatically by Memeo Instant Backup. You don't have to take any additional steps to ensure your files are protected.

TIP: If you're an advanced user, upgrade to Memeo Premium Backup for more features, options, and flexibility. Click **Learn More** under Premium Backup in the Seagate Dashboard Application Store.

Accessing and Enjoying Your Files on Your Home Network

You can access your three folders on GoFlex Home from your home network or from anywhere in the world over the Internet. You can watch movies, listen to music, view photos, and open other files in the GoFlex Home Personal and Public folders the same way you would if they were stored directly on your computer. You can also edit, save, or delete files stored on GoFlex Home.

From your home network, you can use the Seagate Dashboard or the Web-based Seagate Share application to access your folders; Mac users can also use the SmartFolderShortcut in

Finder to access their files. When you're away from home, whether you're on a computer or a smart phone, you must use Seagate Share to access your files.

This section explains how to access your files on your home network. For information about accessing your files when you're away from home, see page 43.

Accessing Your Files From the Seagate Dashboard

Note: Mac users—You can use either Seagate Share or the SmartFolderShortcut to access your files. See the next sections for more information.

From the Seagate Dashboard, you can view your three folders and their contents in a familiar folder view, the way they would appear in My Documents.

To access your folders on GoFlex Home:

1. Open the Seagate Dashboard (see page 28).
2. In the My Applications panel, click **Folder View**.

Your three GoFlex Home folders open in a Web browser, but in a folder view similar to My Documents.

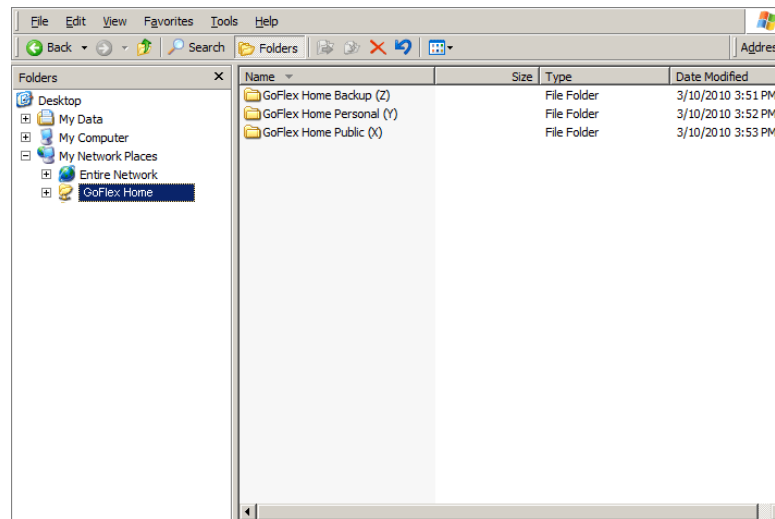

Figure 35: Folder View

TIP: You can also access your three GoFlex Home folders from My Computer by expanding **My Network Places** and clicking **GoFlex Home**.

3. Watch movies, listen to music, view photos, and open other files from your GoFlex Home folders the same way you would if they were stored directly on your computer.

Accessing Your Files From Seagate Share

1. Open Seagate Share and log in (see page 31).
2. Click **Seagate Share**.

The Seagate Share window opens.

3. In the Content panel, click the folder that contains the files you want.

The files in that folder appear in the Main panel on the right.

4. Watch movies, listen to music, view photos, and open other files from your GoFlex Home folders the same way you would if they were stored directly on your computer. See “Enjoying and Managing Your Files in Seagate Share” on page 50 for more information.

Accessing Your Files with the SmartFolderShortcut

Note: The tasks in this section are only available on Macs. Windows users must use the Seagate Dashboard or Seagate Share to access their files.

On computers running the Mac operating system:

1. Open your GoFlex Home folders in a familiar folder view by opening **Finder**, then clicking **Applications > GoFlex Home Desktop Applications > SmartFolderShortcut**.

2. Watch movies, listen to music, view photos, and open other files from your GoFlex Home folders the same way you would if they were stored directly on your computer.

Accessing and Enjoying Your Files When You're Away from Home

You can access your three GoFlex Home folders from anywhere in the world over the Internet. Whether you're on your computer, smart phone, or other device, you have to use Seagate Share to access your files remotely.

You can watch movies, listen to music, view photos, and open other files in the GoFlex Home Personal and Public folders the same way you would if they were stored directly on your computer. You can also edit, save, or delete files stored on GoFlex Home.

To access your files remotely, follow the instructions in "Accessing Your Files From Seagate Share" on page 42.

Sharing Your Files with Friends and Family

Once you have copied files to GoFlex Home, you can compile collections of music, movies, photos, and other documents to enjoy yourself or share with friends and family. (Seagate Share Pro subscribers can also share photos on Facebook and Flickr, and by RSS—Really Simple Syndication—feeds.)

This section explains how to compile collections of files into *shares*, which are similar to playlists, and make them available to others over the Internet.

Creating a Share

A *share* is a collection of related music, movies, photos, and documents that you assemble yourself from your GoFlex Home folders. A share doesn't contain copies of your files, just *references* to files, so it takes up very little room on GoFlex Home. (If you delete a file from its folder, change the name of the file or folder it's in, or move the file or folder, the file disappears from any share in which it's included.)

To create a share:

1. Open Seagate Share and log in (see page 31).

2. Click **Seagate Share**.

The Seagate Share window opens.

3. In the Shares panel, press the plus sign (+).

The Create Share window opens.

4. Enter a name and a description for the share, then select a theme, which adds a background image to the share.

5. Click inside the **Enable Sharing** box.
6. Click inside the Sharing boxes to grant access to your share to whomever you want:
 - Click **Share with Other Family Accounts** to make your share available to everyone on your home network who can access your GoFlex Home.
 - Click **Share with Friends** to make your share available to specific people outside your home network, then click **OK**.

Enter at least one e-mail address, then set a share-until date and add password protection to your share, if you want, then click **Send Invitations**.

Note: The first time you invite friends to view a share, Seagate Share prompts you for your e-mail address, which is used as the return address on the invitation sent by Seagate Share. You can change your e-mail address later, if you want (see page 62). If you choose to add password protection to your share, the people you invite to view it are prompted to create a password before they can view the share. (See “Setting Up and Managing an E-mail Address Book for Shares” on page 60 for more information.)

- Click **Share with Everyone** to make your share available (and searchable) on the Internet and through RSS feeds, then set a share-until date, if you want.
 - Click **Share with Media Devices** to make your share available to the digital media devices on your home network (see page 48).
7. By default, **Allow Downloads for this Share** is enabled, which lets others download the original, full-resolution version of all the files in the share. This is particularly useful for shares that include documents you want to share with others, because the share itself contains only a references to files, not copies of the files themselves.
 8. Click **Create**.

The share is created.
 9. To add content to your share, in the Content panel, select the folder you want then drag and drop either the entire folder or selected files into the share.
 10. View your completed share by double-clicking the share in the Shares panel.

The share opens, showing the background you chose and the description you added during setup. Within the share window, you have options to change the view of the contents, start a slide show, play music included in the share, and download the files in the share to your computer.

11. Click the arrow in the share toolbar to return to the main Seagate Share page.

Note: If you chose to allow specific people to access your share in Step 6, GoFlex Home automatically sends an e-mail to them, using your GoFlex Home e-mail address as the “from” address. See “Customizing Your GoFlex Home User Settings” on page 62 to learn how to set your GoFlex Home e-mail address.

Copying Your Photos from GoFlex Home to Facebook

Note: This feature is available to Seagate Share Pro subscribers only.

If you create a share that includes pictures and photos, you can use GoFlex Home to create a photo album on your Facebook profile.

To create a photo album on Facebook using your GoFlex Home share images:

1. In the Shares panel, move your mouse over the share, click the arrow that appears, then click **View Details**.

The Details panel opens.

2. Click **Social Networking Sites**, then click the **Share with Facebook** box.

The Service Authorization window opens. (This may take a few moments.)

3. Click **Facebook**.

Another window opens, prompting you to authorize Seagate Share to link with your Facebook account.

4. If necessary, enter your Facebook account information, then close the browser window.

5. Click **Authorization Complete**.

6. Select an existing Facebook photo album, or create a new album, then click **Submit**.

Seagate Share copies your photos from GoFlex Home to Facebook. (No music, movie, or document files in the share are copied to Facebook.)

7. Log in to Facebook, then navigate to the photo album where your images are.

8. Select the photos you uploaded, then click **Approve Selected Photos**. Once you have approved the photos, you can edit, organize and share them normally.

If you add more photos to the same share on GoFlex Home, Seagate Share automatically copies them to Facebook. You must approve these new photos before they appear in your Facebook profile. Removing photos from the share doesn't remove them from Facebook.

Copying Your Photos from GoFlex Home to Flickr

Note: This feature is available to Seagate Share Pro subscribers only.

If you create a share that includes pictures and photos, you can use GoFlex Home to add your photos to your Flickr photostream.

To add your GoFlex Home share images to your Flickr photostream:

1. In the Shares panel, move your mouse over the share, click the arrow that appears, then click **View Details**.

The Details panel opens.

2. Click **Social Networking Sites**, then click the **Share with Flickr** box.

The Service Authorization window opens. (This may take a few moments.)

3. Click **Flickr**.

Another window opens, prompting you to authorize Flickr to use Seagate Share.

4. If necessary, enter your Flickr account information, then click **OK, I'll Authorize It**.

5. Close the browser window, then click **Authorization Complete**.

6. Select the default photostream, an existing set, or create a new set by entering a name and optional description, then click **Submit**.

Seagate Share copies your photos from GoFlex Home to Flickr. (No music, movie, or document files in the share are copied to Flickr.)

If you add more photos to the share on GoFlex Home, Seagate Share automatically copies them to Flickr. Removing photos from the share doesn't remove them from Flickr.

Sharing Your Files with RSS Feeds

Note: This feature is available to Seagate Share Pro subscribers only.

RSS stands for Really Simple Syndication, and is a method of distributing frequently updated Web content (like news sites and blogs) to a large number of people. You can subscribe to an RSS feed to stay up-to-date on your favorite sites.

With GoFlex Home, others can subscribe to an RSS feed to stay up-to-date on the content of your shares, if you make them available to everyone (see Step 6 on page 44). Only photos and other images appear in the RSS feed; music, movie, and document files are not included.

If your share is available to everyone, an RSS icon automatically appears in the share toolbar. If someone viewing the share clicks its **RSS** icon, the share opens in an RSS reader, which shows the name and description of the share, and shows its images sorted by name.

The RSS reader then automatically receives new images as you add them to the share, and deletes them when you remove them from the share.



Figure 36: RSS Icon

Setting Up a Centralized Printer

If you connect a printer to the USB port on GoFlex Home, everyone on your GoFlex Home network storage system can share it and wirelessly print from a central location.

Note: This section describes the basic steps to add a USB printer to GoFlex Home. For more information and complete instructions for your specific computer, refer to the documentation that came with your operating system. (Search for information about sharing a printer, connecting to a network printer, or connecting to an Internet or intranet printer.)

To connect a USB printer to GoFlex Home:

1. Use a high-quality USB cable (not included) to connect your USB printer to the USB port on the back of the GoFlex Home dock. See Figure 2 on page 7 for help locating the USB port.

TIP: You can also connect a USB hub to the GoFlex Home dock, then connect your USB printer to the hub.

2. Turn on the printer.
3. Add your USB printer to the list of printers available on your computer:

On Windows:

- a. From the Control Panel, double-click **Printers and Faxes**.
- b. Click **Add a Printer**. When the wizard opens, click **Next**.
- c. Click **A network printer, or a printer attached to another computer**, then click **Next**.
- d. Connect to your USB printer by searching or browsing for it, then follow the on-screen instructions to complete the connection.

On Mac:

- a. Go to System Preferences, click **Print & Fax**, then click the plus sign (+).
- b. Click **Windows**, select **seagategroup**, and then select **goflex_home**.
- c. Select **Registered User**, enter your user name and password, then click **Connect**.
- d. Choose the option **Select a driver to use** in the Print Using using field and then click **Add**.

4. Repeat these steps for the other computers on your GoFlex Home network storage system, as required.

You can now print to and manage the USB printer from your computer, the same way you would if it was physically or wirelessly connected. Keep in mind that it's a shared printer and that others connected to GoFlex Home will be using it, too, on a first-come, first-print basis.

TIP: In Explorer and Finder, your printer appears as a network device.

Enjoying Your Files on a Digital Video Player or Game Console

You can play movies, listen to music, and view photos stored on GoFlex Home from a digital media device that's connected to your home network.

The media device can be:

- A gaming console
- A digital video player (such as FreeAgent Theater+ or FreeAgent GoFlex TV)
- A digital photo frame
- An iTunes® client
- An IP television
- A networked sound system (such as Sonos®)

The media device must support one of these connection technologies:

- UPnP-AV (Universal Plug-and-Play Audio and Video)
- DLNA (Digital Living Network Alliance)
- Windows Media Connect

Before your media device can discover and play the digital media files on your GoFlex Home, you have to make them available.

TIP: Only the files supported by your media device will be detected and available for viewing or listening. See your media device documentation for a list of supported file types.

To make your digital media files available to the media devices on your home network:

1. Open Seagate Share and log in (see page 31).
2. Click **Seagate Share**.

The Seagate Share page opens.

3. In the Content panel, move your mouse over the folder that contains the files you want, click the arrow that appears, then click **Share with Media Devices**.

All the supported media files in the folder are now available from any media device connected to your home network. If the folder you've chosen has subfolders inside it, all the files they contain are shared as well.

To make the files in the folder unavailable to media devices, repeat Steps 3 and 4, selecting **Unshare with Media Devices** in Step 4.

5. Enjoying and Managing Your Files in Seagate Share

This chapter explains how to use Seagate Share to enjoy and manage the files you've stored on GoFlex Home.

To learn more about the Seagate Share application, how to navigate its pages, and how to work with your files and folders, see "Opening Seagate Share" on page 31.

Note: Some of the features described in this chapter are available to Seagate Share Pro subscribers only. See "About Seagate Share Pro" on page 8 for more information.

Playing Music

This section explains how to use Seagate Share and iTunes to enjoy the music files stored on GoFlex Home.

Playing Music in Seagate Share

To play music stored in a Seagate Share folder:

1. On The Seagate Share page, navigate to the folder that contains the music you want to hear.
2. Double-click the song you want.

Seagate Share plays the song, then continues playing all the other songs in the folder. (It won't play songs in any subfolders that might be in the folder you've chosen.) The song's album art and the name of the current song appear on-screen, too.

You can control playback by using the playback toolbar at the bottom of the screen. Click the return icon in the toolbar to stop playback and return to the Seagate Share page.

To play music in a share:

1. On The Seagate Share page, navigate to the share that contains the music you want to hear.
2. Double-click the song you want.

Seagate Share plays the song, then continues playing all the other songs in the share.

Playing Music with iTunes

Everyone on your GoFlex Home network can use iTunes to stream music stored on GoFlex Home. (You can't use iTunes to play music when accessing GoFlex Home from outside your home network.)

To create an iTunes library that all GoFlex Home users can access:

1. Open and log in to Seagate Share (see page 31).
2. In the Content panel, click the **GoFlex Home Public** folder, then click the plus sign (+).
The New Folder window opens.
3. Enter a name for the folder (for instance, iTunes Library), then click **Create**.
The new folder is created.
4. Add songs to the new folder by dragging and dropping files into the folder.
5. In the Content panel, move your mouse over the new folder, click the arrow that appears, then click **Share with Media Devices**. (If the Share with Media Devices option is not available, the folder is already enabled for sharing.)
6. On your computer, open iTunes. In the **Edit** menu, click **Preferences**, then select the **Sharing** tab and ensure that **Look for Shared Libraries** is selected.

All music files stored in your new folder appear in the iTunes SHARED > GoFlex Home:iTunes folder. You can play these songs within iTunes, but you cannot add them to a playlist. Photos, movies, and documents stored on GoFlex Home are not available within iTunes.

Up to five computers or media devices on your home network can play iTunes DRM (Digital Rights Management) protected music, but an unlimited number of computers and media devices can play iTunes Plus music or songs imported from CD.

Playing Movies and Videos

To play a movie or video stored on GoFlex Home:

1. On The Seagate Share page, navigate to the folder that contains the movie you want to watch.
2. Double-click the movie file.

Seagate Share opens and plays the movie.

You can control playback by using the playback toolbar at the bottom of the screen. Click the return icon in the toolbar to stop playback and return to the Seagate Share page.

Enjoying Your Photos

This section explains how to view your pictures and photos, start a photo slideshow, and make one of your photos a background image for your Seagate Share Home page. It also explains how to access Cooliris, a Web-based application for viewing photos in a 3D display (available with a Seagate Share Pro subscription—see page 8).

Viewing Photos

To view photos stored on GoFlex Home:

1. On The Seagate Share page, navigate to the folder that contains the photos you want to see.
2. Double-click any photo to open it.

To rotate an image:

1. In the Content panel, click on the folder that contains the photo you want to rotate.
2. In the Main panel, move your mouse over the photo you want, click the arrow that appears, then click **Rotate Clockwise** or **Rotate Counterclockwise** (as required).

The photo is rotated. If the photo is included in a share, it's rotated there, as well.

Viewing Photos as a Slideshow

You can view all the photos contained in a folder in an automated slideshow. (The slideshow won't include photos in any subfolders that might be in the folder you've chosen, and it won't play any music stored with your photos.)

To view photos as a slideshow:

1. On The Seagate Share page, navigate to the folder or share that contains the photos you want to see.
2. In the Content or Shares panel, move your mouse over the folder or share you want, click the arrow that appears, then click **Slideshow**.

A slideshow begins. Each photo displays for a few moments, along with its caption. (See page 55 for more information about captions.)

You can control the slideshow by using the playback toolbar at the bottom of the screen. Click the return icon in the toolbar to stop the slideshow and return to the Seagate Share page.

Making a Photo Your Home Page Background

You can use one of your photos as a background image for the Home page of Seagate Share (the first page that opens after you sign in).

To make a photo your Home page background:

1. On The Seagate Share page, navigate to the folder or share that contains the photo you want to use.
2. In the Main panel, move your mouse over the photo you want, click the arrow that appears, then click **Use as Home Page Background**.
3. In the **Go To** menu, click **Home**.

Your photo appears as a background image. You can set the size of the image, or clear it completely, by changing your GoFlex Home user settings on the Preferences page. See "Customizing Your GoFlex Home User Settings" on page 62 for instructions.

Viewing Your Photos in Cooliris

Note: This feature is available to Seagate Share Pro subscribers only (see page 8).

Cooliris provides an innovative user interface to display the images in your GoFlex Home folders and shares.

To open and view your photos in Cooliris:

1. On The Seagate Share page, navigate to the folder or share that contains the photo you want to use.
2. Double-click the share. Your photos open in Cooliris, and the name of the share, its description, and the theme you choose when you created the share appear, as well.

OR

Select the folder you want, then in the Search/View toolbar, select **Cooliris** in the **Views** list.

3. After selecting the Cooliris view, move your mouse over **View This In 3D**, then click **Get Cooliris** to install the Cooliris plug-in, which will allow you to enjoy all the Cooliris features.

Managing Files and Folders

This section explains how to add, delete, rename, move, and manage the files and folders you've stored on GoFlex Home.

TIP: Remember that Seagate Share provides several ways of doing the same task. The steps in the following sections describes one possible way of completing a task. See "Completing Tasks Multiple Ways in Seagate Share" on page 34 for alternatives.

Adding and Deleting Folders

You can add and delete folders within your GoFlex Home Public and Personal folders by using the plus sign (+) and minus sign (-) in the Content panel. If you delete a folder, any files within that folder that are included in a share won't be available from the share anymore.

Caution: Deleting a folder deletes all the files stored inside it.

To add a folder:

1. On The Seagate Share page, click the plus sign (+) in the Content panel.
The New Folder window opens.
2. Enter a name for the folder, then click **Create**.
The new folder is created.
3. Add files to the new folder by dragging and dropping them into the folder.

To delete a folder:

1. On The Seagate Share page, select the folder you want to delete

Caution: Deleting a folder deletes all the files stored inside it.

2. Click the minus sign (-) in the Content panel, then click **Yes** to confirm the deletion.

Moving a Folder

You can move any folder within your GoFlex Home Public and Personal folders, and can even move a folder between the Public and Personal folders.

To move a folder, drag and drop it to the location you want. You can also use the folder menu (see page 35) to **Cut** and **Paste** the folder from one location to another.

Copying a Folder

When you copy a folder, the original stays where it is and you place a second version in another location. Nothing is removed from the original folder or location.

To copy a folder in Seagate Share, use the folder menu (see page 35) to **Copy** and **Paste** the folder to a new location.

Renaming a Folder

TIP: If you rename a folder, its files will no longer be available in any existing share that contains the folder.

To rename a folder:

1. Move your mouse over the folder you want, click the arrow that appears, then click **Rename**.

The Rename Folder window opens.

2. Enter a new name, then click **Rename**.

The folder is renamed.

Adding Files to a Folder

You can add files to a folder one of two ways:

- On the Seagate Share page, drag and drop files from one folder to another on GoFlex Home.
- Copy new files from your computer to the GoFlex Home folder you want. See “Copying Files to GoFlex Home Using Seagate Share” on page 38 for instructions.

Moving a File to Another Folder

You can move files from one folder to another by dragging and dropping them where you want them to be. You can also use the file menu (see page 35) to **Cut** and **Paste** the folder from one location to another.

TIP: If you move a file to another folder, it will no longer be available in any existing share.

Copying a File

When you copy a file, the original stays where it is and you place a second version in another location. Copying a file duplicates the original full-resolution version stored in the folder, not the compressed version that appears in Seagate Share. Nothing is removed from the original location. Remember that each copy of a file takes up the same amount of storage space on your GoFlex Home.

To copy a file, use the file menu (see page 35) to **Copy** and **Paste** it to a new location.

Renaming a File

You can rename any file that's within a folder, if necessary.

TIP: If you rename a file, it will no longer be available in any existing share.

To rename a folder:

1. Move your mouse over the file you want, click the arrow that appears, then click **Rename**.

The Rename File window opens.

2. Enter a new name, then click **Rename**.

The file is renamed.

Adding Captions and Tags to Your Files

A file's *caption* is a description of the file, and it appears whenever you view a file within a folder or a share. (*Seagate Share Pro subscribers*—Photo captions also appear when you share your photos through Facebook, Flickr, or RSS feeds.) You can use caption text to search for a file.

A file's *tags* store additional information about a file. Tags appear in the Details panel of the Seagate Share page when you view a file within a folder. Tags don't appear in shares, or when you post your photos on Facebook, Flickr, or by RSS feed. You can use tags to search for a file. If you tag files consistently, you will be able to find the files you're looking for more easily, especially as their numbers grow over time.

To add a caption and/or tags to a file:

1. On The Seagate Share page, navigate to the folder that contains the file you want.
2. Move your mouse over the file you want, click the arrow that appears, then click **View Details**.

A Details panel opens on the Seagate Share page.

3. Enter a caption in the **Caption** box.

For example: *Our New Kittens*

4. Enter the tags in the **Tags** box.

For example: *cats, kittens, pets, Zeppo and Zoey*

5. Repeat the steps in this section until all the files you want to describe and tag are done.

Downloading a File

You can download any file in your GoFlex Home Personal or Public folders to your computer. When you download a file, you download the original full-resolution version of the file.

To download a file:

1. On The Seagate Share page, navigate to the folder that contains the file you want.
2. Move your mouse over the file, click the arrow that appears, then click **Download**.

A window opens, listing the files within that folder.

3. Click the **Download** button beside the file you want.
4. Follow the on-screen instructions to open or save the file.

Deleting a File from a Folder

You can delete files from your GoFlex Home Personal and Public folders. You can delete single files or multiple files simultaneously.

TIP: If you delete a file, it will no longer be available in any share.

To delete a folder:

1. On The Seagate Share page, move your mouse over the file you want to delete.

OR

Select multiple files to delete from the same folder, then move your mouse over the selected files.

2. Click the arrow button that appears, then click **Delete**.
3. Click **Yes** to confirm the deletion.

Managing Your Shares

Once you have created a share (see page 43), you can use Seagate Share to add files to it, remove files from it, rename it, and manage the access settings to limit or expand who can view it. You can also delete an entire share.

TIP: Keep in mind that files appear in shares by reference only—your original files remain in their original locations inside your GoFlex Home folders. If you move, delete, or rename a file or its folder, any share that references that file won't be able to access it anymore. However, deleting a share does not delete the files it contains.

Accessing Your Shares

You can find your shares listed in two places in Seagate Share:

- The Shares panel of the Seagate Share page
- On the Shares page

To open the Shares page, log on to Seagate Share (see page 31), click **Go To** in the Navigation toolbar, then click **Shares**.

Viewing a Share

To view a share:

1. In the Shares panel, double-click the share you want.

The share opens, showing the background you chose and the description you added during setup. Within the share window, you have options to change the view of the contents, start a slide show, play music included in the share, and download the files in the share to your computer.

2. Click the arrow in the share toolbar to return to the main Seagate Share page.

Adding Files to a Share

To add a file or the contents of a folder to any existing share:

1. On The Seagate Share page, navigate to the file or folder you want.
2. Move your mouse over the file or folder, click the arrow that appears, click **Add to Share**, then click the name of the share.

The file or folder is added to the share.

Removing a File from a Share

Removing a file from a share means that the file isn't available in the share anymore; it doesn't delete the file from its original location in your GoFlex Home folders. You can remove multiple files from a share simultaneously.

To remove a file from a share:

1. On The Seagate Share page, navigate to the share you want.
2. Move your mouse over the file you want to remove.

OR

Select multiple files to remove, then move your mouse over the selected files.

3. Click the arrow that appears, then click **Remove**.

The files are removed from the share, but not deleted from their original locations on GoFlex Home.

Creating a Share that Only You Can Access

To create a share that only you can access:

1. On The Seagate Share page, navigate to the folder you want.
2. Move your mouse over the folder, click the arrow that appears, click **Add to Share**, then click **New**.

By default, the share has the same name as the selected folder.

3. *(Optional)* Enter a name and description for the share, enter a **Description**, and select a theme, which adds a background image to the share.
4. Click **Submit**.

The share is created. You can invite others to view your share at any time by changing its Sharing settings:

- a. Move your mouse over the share, click the arrow that appears, then click **View Details**.
- b. In the Details panel, click **Sharing**.
- c. Select the people or groups you want to share with. See “Creating a Share” on page 43 for more information.

Disabling Sharing on a Selected Share

Disabling sharing prevents others from viewing your share.

To disable sharing:

1. On The Seagate Share page, navigate to the share you want.
2. Move your mouse over the share, click the arrow that appears, then click **View Details**.
3. In the Details panel, clear the **Sharing** option.

Seagate Share Pro users—Clear the **Social Networking Sites** options, as well.

Sharing is disabled for the selected share.

Renaming a Share

You can rename any share, if necessary.

TIP: If you rename a share that others have been invited to view, the original link to the share will no longer work. Resend invitations with the new link, if necessary.

To rename a share:

1. Move your mouse over the share you want, click the arrow that appears, then click **Rename**.
The Rename Share window opens.

2. Enter a new name, then click **Rename**.

The share is renamed.

Creating Cover Art for a Share

You can use a photo, a document, or an image from a music or movie file as the cover art for a share. The cover art appears as the share icon on the Shares page of Seagate Share. (If you set a document as the cover, a generic document icon is used.)

To use a file as the cover art of a share:

1. On The Seagate Share page, navigate to the share you want.
2. In the Main panel, move your mouse over the file you want, click the arrow that appears, then click **Use as Share Cover**.

The file becomes the share's cover art.

Downloading a File from a Share

When you create a share and you or others view it, the share streams compressed images to conserve bandwidth and improve performance. You can configure a share to allow those viewing it to download original full-resolution versions of the files.

Allowing downloads is especially important if the share contains documents, because the share references these files but cannot open them. (To allow downloads from a share, see Step 7 of "Creating a Share" on page 43.)

If a share allows downloads, you can download all the files in a share from the Shares page, or selected files from a share that you're currently viewing.

To download all the files using the Shares page:

1. On The Seagate Share page, click **Go To** in the Navigation toolbar, then click **Shares**.
2. Select the share you want, then click **Download** in the toolbar.

A window opens, listing all the files in the share.

3. Click the **Download** button beside the files you want.
4. Follow the on-screen instructions to open or save the files.

To download individual files from a share that you're currently viewing:

1. Select one or more files, then click the **Download** icon in the toolbar.
2. Click the **Download** button beside the files you want.
3. Follow the on-screen instructions to open or save the files.

Deleting a Share

Deleting a share means that others can no longer access the files it contained; however, the files themselves remain in their original GoFlex Home folders.

Seagate Share Pro users—If you copied photos from a share to your account on Facebook or Flickr, your photos will remain on those sites. However, if you invited others to view your share using RSS, your photos will no longer be available to the RSS readers.

To delete a share:

1. On The Seagate Share page, select the share you want to delete, then click the minus sign (-) in the Share panel.
2. Click **Yes** to confirm the deletion.

Setting Up and Managing an E-mail Address Book for Shares

When you create a share, you can choose to invite specific friends and family to view it. Seagate Share e-mails them an invitation that contains a link to the share.

To make sending invitations easy, you can set up an e-mail address book in Seagate Share, then add to or edit it as required. When you want to invite others to view a share, you can choose which contacts to include from the list.

To set up your address book in Seagate Share:

1. On The Seagate Share page, select an existing share. (To create your first share, see page 43.)
2. Move your mouse over the share, click the arrow that appears, then click **View Details**.
The Details panel appears.
3. Click **Sharing**, then select **Share with Friends** (if it isn't selected already).
4. In the Share with Friends box, click the icon with the plus sign (+) on it.
The Share with your Contacts window opens.
5. Click the **Create New Contact** icon under the address book, enter the first name and e-mail address, then click **Add**.

Your first contact is added to your address book.

6. Continue adding contacts, following the steps in this section.

Your contact list is now available in any existing or new share.

To edit information in your address book, select the name in the Address Book list, click the **Edit Contact** icon, then change the name and/or e-mail address.

To remove someone from your address book, select them in the Address Book list, then click the **Delete Contact** icon.

Accessing Your GoFlex Home Files Using FTP

You can access your GoFlex Home using FTP (File Transfer Protocol). FTP is one way of copying files from one computer or storage device to another. You can upload files to and download files from any of your GoFlex Home folders using FTP.

Note: You should be familiar with FTP before using this feature. For security reasons, don't enable FTP access unless or until you need it. Seagate Share Pro subscribers can access GoFlex Home using the more secure FTPS.

FTP access must be enabled in Seagate Share before you can use FTP to access your GoFlex Home. To enable FTP in Seagate Share:

1. Open and log in to Seagate Share (see page 31).
2. Click **Go To**, then click **Preferences**.
3. Under Server Preferences, click **Network Services**.
4. Set **Enable FTP access to your local LAN** and **Enable FTP access to the Internet** to **Yes**.
5. Click **Submit**.

FTP access is enabled.

6. Ensure that your router is set to forward port 21 to your GoFlex Home. This is set up automatically if your router has UPnP enabled.
7. To connect to GoFlex Home using FTP locally, open a browser and browse to:

ftp://yourGoFlexHomeIPAddress

You can find the IP address of your GoFlex Home by (Mac) right-clicking the GoFlex Home Agent icon, selecting **Preferences**, and then selecting the **GoFlex Home Found** tab, or (Windows) by finding GoFlex Home in the list of Network devices and looking at its properties.

To connect to GoFlex Home using FTP remotely, open a browser and browse to:

ftp://GoFlexHomeName.seagateshare.com

When you log in to GoFlex Home, remember that your user name and password are case-sensitive.

6. Managing GoFlex Home

Once your GoFlex Home network storage system has been set up, you can change your personal GoFlex Home settings, add new applications to your computer, manage user accounts, and manage your GoFlex Home and any devices connected to it.

Note: Some of the tasks described in this chapter can be only be done by someone with a user account that includes permission to change GoFlex Home settings. If you can't complete a task included in this chapter, ask your home network manager to update your account permissions or do the task for you.

Changing Your Own GoFlex Home Password

You use your GoFlex Home password to log into the Seagate Dashboard (Windows users only) and to log in to GoFlex Home from the Seagate Share application or FTP connection. You can change your password at any time.

To change your password:

1. Open the Seagate Dashboard (see page 28), then click **Preferences**.
OR,
Open and log in to Seagate Share (see page 31), click **Go To**, then click **Preferences**.
2. On the Preferences page, click **Change Password**.
3. Enter and confirm your new password. Passwords must be at least six characters long and must include one number. Passwords are case-sensitive.
4. Click **Submit**.

Your password is changed.

Customizing Your GoFlex Home User Settings

You can customize your GoFlex Home account by personalizing the default settings for sharing new files, adding your own e-mail address for sending share invitations, and choosing your preferred language.

To customize your GoFlex Home user settings:

1. Open the Seagate Dashboard (see page 28), then click **Preferences**.
OR,
Open and log in to Seagate Share (see page 31), click **Go To**, then click **Preferences**.

2. On the Preferences page, click **User**.
3. Change your preferences as required:
 - **Language:** Sets the language of the Seagate Share application.
 - **Sharing Emails Sender:** Sets the return e-mail address for the invitations to view your shares that Seagate Share sends out (see “Creating a Share” on page 43).
 - **Home Background Position:** Sets the size of the image (if any) used on the Seagate Share Home page. Click **Clear Home Background** to not use an image on the Home page. (See “Making a Photo Your Home Page Background” on page 52 for more information.)
 - **What to do when a file already exists:** Determines what happens when you copy or move a file to a folder that already contains a file with the same name.
 - **Share new content with other family accounts...:** Sets the access default for allowing others on your GoFlex Home network storage system to access new shares; you can override this default setting when you create a new share.
 - **Share new content with media devices...:** Sets the access default for allowing media devices to access new shares; you can override this default setting when you create a new share.
 - **Resume Audio Playback:** Determines whether or not playback automatically starts with the first song or movie in a folder or share. If you select **No**, songs and movies start at the beginning when you play them; if you select **Yes**, Seagate Share automatically offers to resume a song or movie where you stopped it on a previous occasion.
 - **Hide Help Tips:** Enables or disables the tip box that appears whenever you open Seagate Share.
 - **Reset all ‘Do not show again’ prompts:** Re-enables the help windows you disabled previously.
4. Click **Submit**.

Your settings are updated.

Adding New GoFlex Applications to Your Computer

The bottom panel of the Seagate Dashboard is the Application Store, a service from Seagate that offers applications you can install on your computer for use with your storage devices.

In the Application Store, you can browse the list of applications, try out the ones you’re interested in, and purchase the ones you like. The list of applications is updated regularly, so check back often to see what’s new.

TIP: Mac users—Some applications available in the Seagate Dashboard, such as Memeo Premium Backup, are available for Mac computers.

You can install and try out many applications for free for a limited amount of time. When the free trial period is over, you're given the option to purchase and install the full version.

To learn about or install a free trial version of an application:

1. Open the Seagate Dashboard (see page 28).
2. Find the application you want in the Application Store.
TIP: Click **See All** to view all available applications.
3. Under the application, click **Learn More**.

Or,

Click **Install** to install a free-trial version of the application.

When the free trial period is over, you can choose whether or not to purchase and install the full version of the application.

Adding and Managing User Accounts

This section explains how to add a new user to your GoFlex Home network storage system, edit the details of existing user accounts, or remove a user account from GoFlex Home.

Note: To complete the tasks in this section, you must have a user account that includes permission to change GoFlex Home account settings.

Adding a New User Account to GoFlex Home

You can add new users to GoFlex Home at any time.

TIP: Remember that GoFlex Home includes accounts for up to five people/computers. To create user accounts for more than five people, you must upgrade to Seagate Share Pro. See page 8 for more information.

Adding a User from the Seagate Dashboard

Note: **Mac users**—You must use Seagate Share to add a new user account to GoFlex Home. See page 65.

To add a new user to GoFlex Home:

1. Open the Seagate Dashboard (see page 28).
2. In the How to... panel, click **Add Users**.
3. Follow the on-screen instructions. See “Step 5: Adding a User to GoFlex Home” on page 15 for more information.

Adding a User from Seagate Share

To add a new user to GoFlex Home:

1. Open and log into Seagate Share (see page 31).
2. On the Home page, click **Preferences**.
3. Click **Add New User**.
4. Enter the user name in the Account User Name field.

User names must start with a letter and must be at least three characters in length. User names are not case-sensitive. You can't use the same user name twice on GoFlex Home.

5. Enter a display name for the user. This name can be different from the Account User Name, if you want.
6. Enter and confirm a password.

Passwords must be at least six characters long and must include one number. Passwords are case-sensitive.

7. Select **Create as Administrator** if you want this person to be able to do the same home network manager tasks as you.
8. Click **Submit**.

The user account is created, and the person can begin using GoFlex Home as soon as their computer is added to your GoFlex Home network storage system (see page 17 for Windows or page 26 for Mac).

Editing or Removing an Existing User Account

You can change the details of an existing GoFlex Home user account at any time. You can:

- Change the password.
- Give or remove manager permissions, which allow the user to change GoFlex Home account settings.
- Give or remove access to the GoFlex Home Public folder.

If necessary, you can also remove a user account from GoFlex Home. You might want to do this to make one of your five included user accounts available to someone else in the household, or to shut down the account of someone who no longer requires access to your GoFlex Home network storage system.

To edit or remove an existing user account:

1. Open the Seagate Dashboard (see page 28), then click **Preferences**.

OR,

Open and log in to Seagate Share (see page 31), click **Go To**, then click **Preferences**.

2. Click **Edit User.**

The Edit User screen opens.

3. Select the user name, make the required changes, then click **Submit.**

Or,

Select the user name, click **Delete**, then click **OK** to confirm.

The user account is updated or deleted. If you changed someone's password, make sure to share the new one with him or her.

Managing GoFlex Home and Connected Devices

This section explains how to properly maintain your GoFlex Home device and how to add and remove GoFlex and USB drives.

Updating the GoFlex Home Software

To get the most out of your GoFlex Home, update its software whenever a new version is released.

To update the software on your GoFlex Home device:

1. Open the Seagate Dashboard (see page 28), then click **Preferences.**

OR,

Open and log in to Seagate Share (see page 31), click **Go To**, then click **Preferences**.

2. Click **Software Updates.****3. Click **Check Now**.**

If updated software is available, follow the on-screen instructions to update the software.

Adding a USB Drive to GoFlex Home

GoFlex Home provides a USB port that you can use to connect additional storage devices, such as a USB flash drive (also known as a thumb drive) or external USB hard drive. When connected to GoFlex Home, a USB drive appears as an External Storage folder on GoFlex Home, next to the Public, Personal, and Backup folders.

To add a USB drive to GoFlex Home, connect it directly to the USB port on the back of the GoFlex Home dock, or use a high-quality USB cable (not included). See Figure 2 on page 7 for help locating the USB port. (You can also connect a USB hub to GoFlex Home, then connect additional devices to it.)

Removing a USB Drive from GoFlex Home

To avoid losing data or damaging your files, always follow these instructions to safely and properly shut down and remove a USB storage device from the GoFlex Home dock:

1. Make sure that no files on the USB device are open or in the process of being saved, and that no one connected to your GoFlex Home is copying files to or from it.
2. Open the Seagate Dashboard (see page 28), then click **Preferences**.

OR,

Open and log in to Seagate Share (see page 31), click **Go To**, then click **Preferences**.

3. Click **Storage Devices**.

The Storage Devices screen opens.

4. Select the device you want to shut down, click **Eject**, then click **OK** to confirm.

When the USB drive is shut down, you can safely remove it from the GoFlex Home dock.

Safely Removing the GoFlex Drive from the GoFlex Home Dock

To avoid losing data or damaging your files, always follow these instructions to remove the GoFlex drive from the GoFlex Home dock:

1. Make sure that no one is accessing GoFlex Home. No one should be viewing photos, watching a movie, listening to music, or working with any other file stored on GoFlex Home, or copying files to or from their GoFlex Home folders.
2. Open the Seagate Dashboard (see page 28), then click **Preferences**.

OR,

Open and log in to Seagate Share (see page 31), click **Go To**, then click **Preferences**.

3. Click **Shut Down**.

The Shut Down screen opens

4. Click **Shut Down**.

The white drive light on the front of GoFlex Home blinks to show that GoFlex Home is shutting down. When shutdown is complete, both lights turn off.

5. Remove the GoFlex drive by carefully lifting it from the connectors on the dock.

To reinstall the drive and restart GoFlex Home, follow the instructions in “Step 2: Connecting GoFlex Home” on page 10.

Shutting Down and Restarting GoFlex Home

If you experience minor problems with GoFlex Home, follow the instructions in this section to restart it.

Note: Restarting GoFlex Home does not remove any user settings or delete content from the drive.

To shut down and restart GoFlex Home:

1. Make sure that no one is accessing GoFlex Home. No one should be viewing photos, watching a movie, listening to music, or working with any other file stored on GoFlex Home, or copying files to or from their GoFlex Home folders.
2. Open the Seagate Dashboard (see page 28), then click **Preferences**.

OR,

Open and log in to Seagate Share (see page 31), click **Go To**, then click **Preferences**.

3. Click **Shut Down**.

The Shut Down screen opens.

4. Click **Restart**.

GoFlex Home safely shuts down and restarts. When it is fully powered on and connected to your network, it appears in the list of drives at the top of the Seagate Dashboard, and your GoFlex Home folders appear in Explorer and Finder.

Resetting GoFlex Home to Its Original Settings

Resetting GoFlex Home returns the device to its original factory settings. All the files stored on GoFlex Home are retained—no files or folders are deleted—but all other settings, such as user accounts and passwords, are removed.

Note: Reset GoFlex Home only if absolutely necessary, to avoid the lengthy task of re-creating user accounts, re-adding computers to GoFlex Home, reconnecting users to their GoFlex Home folders, and redoing any custom settings.

To reset GoFlex Home:

1. Make sure that no one is accessing GoFlex Home. No one should be viewing photos, watching a movie, listening to music, or working with any other file stored on GoFlex Home, or copying files to or from their GoFlex Home folders.
2. Using a paperclip, press and hold the **Reset** button for ten (10) seconds. The Reset button is located on the side of GoFlex Home, as shown in Figure 1 on page 6.

The white drive light blinks to show that GoFlex Home is shutting down. When shutdown is complete, both lights turn off.

3. Press the **Power** button to restart GoFlex Home, then follow the instructions in “Step 4: Setting Up GoFlex Home” on page 12 to re-activate GoFlex Home, re-add user accounts, and re-add the computers on your home network.

Be sure to re-create user names *exactly*, so that everyone can reconnect to their existing GoFlex Home folders.

TIP: You can also access all the folders and files on GoFlex Home by connecting GoFlex Home directly to your computer using a GoFlex Cable (sold separately). Go to www.seagate.com for more information.

Adding More Storage Capacity to GoFlex Home

If you need additional storage capacity on GoFlex Home in the future, you can connect a USB drive directly to GoFlex Home (see page 66) or upgrade to a new or larger-capacity GoFlex Home or GoFlex Desk drive (see page 67 for instructions on removing and replacing the drive in your GoFlex Home).

If you replace the current drive, you can store it as an archive of all your household backup files, in case a problem occurs on someone’s computer or an important older file is overwritten or deleted by mistake.

For more information about additional GoFlex drives for your GoFlex Home, visit the Seagate Web site at www.seagate.com

Managing GoFlex Home Settings and Preferences

The GoFlex Home Preferences page helps you manage personal and network settings for your GoFlex Home device.

On the Preferences page, you can change your personal information, manage user accounts on your GoFlex Home (if you have permission to do so), change network-related settings, and manage your GoFlex Home device by updating its software or shutting it down properly.

You can open the GoFlex Home Preferences page two ways:

- Open the Seagate Dashboard (see page 28), then click **Preferences**.
- OR,
- Open and log in to Seagate Share (see page 31), click **Go To**, then click **Preferences**.

The Preferences page opens, showing a range of settings. This section describes those settings not already discussed in this chapter.

Server Preferences Settings

This section describes the settings available in the Server Preferences area of the Seagate Share Preferences page.

- **Network Sharing:** Controls whether members of your household can access their GoFlex Home Personal and Backup folders using either Explorer or Finder, as well as access a USB printer connected to GoFlex Home (see “Setting Up a Centralized Printer” on page 47).
- **UPNP Router Configuration:** Controls whether or not Seagate Share configures your router, and whether or not Seagate Share can override your router’s current configuration.

Note: Enable this setting only if you experienced a problem while setting up GoFlex Home. GoFlex Home works with most consumer home network equipment with no special settings required.

- **Notifications:** Sets the e-mail address(es) to be used for occasional system messages. The e-mail addresses entered in this field receive a system message only if there is a problem with the drive, if the drive is full, or if your Seagate Share Pro subscription is expiring soon.
- **Network Services:** Controls whether or not your GoFlex Home can be accessed from an FTP site. For improved security, disable FTP access unless or until you specifically require it. Enabling FTP means that members of your household can use it to upload and download files to their GoFlex Home folders with FTP.

You can limit FTP access to computers on your home network (LAN) only, or enable FTP access from anywhere on the Internet.

- **LAN Connection:** Controls whether or not GoFlex Home connects to your home network using settings it obtains automatically. (Unless you have networking experience, have business-grade network equipment at home, or are experiencing problems when accessing GoFlex Home while you’re travelling, you should set **Obtain IP Address Automatically** to **Yes**. No other input is required.)

If you need to manually set up a LAN connection for GoFlex Home, set **Obtain IP Address Automatically** to **No**, then enter all the required information in the fields that appear:

- **Server IP Address:** Sets the static IP address for GoFlex Home. Obtain the static IP address from your ISP (Internet service provider), and use it to replace the dynamic IP address that appears in the box by default.
- **Server Netmask:** Sets the subnet mask, which determines the address range of the subnet, a separate part of your network. Data sent to addresses within the subnet (for example, between your computer and GoFlex Home) are routed within the network. Data sent to addresses outside the subnet (for example, between a remote user and

GoFlex Home) are routed to the Internet. Most home networks with less than 255 nodes use **netmask.24**.

- **Gateway:** Sets the IP address of the device (most likely your router) that routes data from GoFlex Home to the Internet.
- **Date and Time:** Controls the date and time used by GoFlex Home. You can set GoFlex Home to obtain its settings from the Internet using an Internet time server, or you can set GoFlex Home's date and time yourself. If you set **Set date and time from the Internet to Yes**, select a default NTP (Network Time Protocol) server for best results.
- **Remote Access:** When enabled, allows GoFlex Home to be accessed from anywhere over the Internet. You can use this setting to disable remote access, which was enabled automatically when you set up GoFlex Home.

Administration Settings

This section describes the settings available in the Administration area of the Seagate Share Preferences page.

- **Add New User:** See page 64.
- **Edit User:** See page 65.
- **Shut Down:** See page 68.
- **Software Updates:** See page 66.
- **GoFlex Home Premium Subscription:** Upgrades Seagate Share to Seagate Share Pro, which provides premium service options that are available by yearly subscription. See page 8 for more information.
- **ComputersBackup:** Enables ComputersBackup (which you may have installed on your Mac during setup) to use Time Machine to back up files on your computer to GoFlex Home. Before configuring the backup facility on your computer, you must enable ComputersBackup and create a password. The password will be required when you configure the backup facility on your computer.

You can also delete all backed up data from GoFlex Home by clicking **Wipe**.

Caution: Wiping backups deletes ALL backed up data for ALL GoFlex Home users (not just your own backup files).

- **Storage Devices:** Lets you safely remove a USB drive from GoFlex Home (see page 67). Also lets you format a USB drive to change it to a NTFS (New Technology File System) format for Windows.

Caution: Formatting a USB drive deletes all existing files from the drive.

7. Solving Problems

GoFlex Home is a plug and play device. However, in certain situations, the setup process may require extra attention. Below is a list of troubleshooting tips to assist you should you have any problems during setup.

- Ensure that the supplied power adapter is securely connected to GoFlex Home and to a power source. If you are using a power strip, make sure it is turned on.
- Check that one end of your network cable is securely connected to the Ethernet port on GoFlex Home and the other end is connected to a functioning port on your network router.

If the network cable is securely connected and the light is amber, the network cable or the Ethernet port may not be functioning properly. To test this, connect the network cable to a different port on your router. If there is still no connection, try a different Ethernet cable.

Make sure your router is turned on.

- Ensure that your router gives out IP addresses to computers on your network (DHCP) and that DHCP is enabled on your router. DHCP is usually enabled on home networks. If it is not, you will have trouble connecting to GoFlex Home. If you need assistance enabling DHCP on your router, see your router documentation.
- Ensure that your home network isn't down or disabled, and that your Internet service isn't disrupted.

Common Problems and Solutions

This section provides suggestions for solving common problems.

Why can't I create a new user account?

You may have exceeded the number of user accounts allowed. GoFlex Home includes five user accounts, including the home network manager who set up GoFlex Home initially. To create a new user account, you must either delete an existing account (if someone has left the household, for instance) or upgrade to unlimited user accounts by subscribing to Seagate Share Pro. See page 8 for more information.

Why won't my computer connect to GoFlex Home?

If you have installed the GoFlex Home software on your computer but it won't connect to GoFlex Home, check that your home network is working properly and that the GoFlex Home device is properly connected and powered on.

If other computers are successfully connected to GoFlex Home, you may have exceeded the number of computers allowed. GoFlex Home includes licenses for five computers. To add another computer, you must either delete an existing user account (which disconnects their

computer) or upgrade to unlimited user accounts by subscribing to Seagate Share Pro. See page 8 for more information.

Why can't I use the name I want for GoFlex Home/my user account?

The GoFlex Home device itself must have a name that's completely unique—unused by any other device in the world. You may have to slightly adjust the name you want to make it unique, in the same way you often have to try a few times to find an online user name or e-mail address that's not already in use. Use the **Check Availability** button for help.

Additionally, your GoFlex Home name must start with a letter and must be at least three characters in length. You can use letters, numbers, dashes, dots, and underscores. Spaces are not allowed.

Within your GoFlex Home network storage system, no two user accounts can have the same name, even if they have different computers and different passwords.

Why won't Memeo Instant Backup let me back up more than three computers to GoFlex Home?

GoFlex Home includes access to Memeo Instant Backup for up to three computers. To add more computers, upgrade to Memeo Premium Backup. For more information, click **Learn More** under Premium Backup in the Seagate Dashboard Application Store.

I'm the home network manager and I can't remember my GoFlex Home password. How do I reset it?

If you are the home network manager (the person who set up GoFlex Home originally) and you can no longer remember your GoFlex Home password, follow these instructions to reset your password:

1. Make sure that no one is accessing GoFlex Home. No one should be viewing photos, watching a movie, listening to music, or working with any other file stored on GoFlex Home, or copying files to or from their GoFlex Home folders.
2. Using a paperclip, press and hold the **Reset** button for three (3) seconds. The reset button is located on the side of the GoFlex Home dock, as shown in Figure 1 on page 6.

Caution: Don't hold the Reset button longer than 5 seconds. Holding down the Reset button for 10 seconds erases all your custom GoFlex Home settings (see page 68).

The white drive light blinks to show that GoFlex Home is shutting down. When shutdown is complete, both lights turn off.

3. Press the **Power** button to restart GoFlex Home if the device doesn't restart on its own.

4. On your computer, open a Web browser (such as Explorer or Safari) and enter the GoFlex Home IP address in this format:

http:\\GoFlexHome\IPaddress

For example:

http:\\123.456.789.0

To find the IP address of GoFlex Home on a computer running the Windows operating system, find GoFlex Home in the list of Network devices and check its Properties. (In Windows XP, if GoFlex Home doesn't appear in the network device list, click **Show icons for networked UPnP devices** in My Network Places, then follow the on-screen instructions.)

To find the IP address of GoFlex Home on a computer running the Mac operating system, use the Network Utility in Finder (**Applications > Utilities**).

Why does GoFlex Home seem to shut down by itself?

GoFlex Home includes a power-save feature, which means that GoFlex Home enters a standby state after 12 minutes of no activity. GoFlex Home automatically returns to active mode whenever someone on your network storage system accesses their folders and files.

During setup, someone else logged into the Seagate Dashboard. What can I do?

The Seagate Dashboard allows you to change users. See "Logging In to the Seagate Dashboard" on page 30 for more information.

Alternatively, open Seagate Share (see page 31), click **Sign Out**, then log back in as yourself.

Decoding the GoFlex Home Lights

The lights on the front of the GoFlex Home dock change color and flash to indicate the status of the drive and device. This section explains the meaning of the lights and what to do if a problem occurs.

Table 1: GoFlex Home Light (top)

State	Status
Green blinking	Starting up
Green steady	Connected to the network and ready for use
Amber blinking	Not connected to the network

If the GoFlex Home light indicates a problem:

- Ensure that the drive is properly and fully connected to the dock.

- Ensure that your home network isn't down or disabled. (Look at the lights on the back of the GoFlex Home dock—if they're not on and blinking, GoFlex Home is not connected to your network.)
- Ensure that the Ethernet cable connecting GoFlex Home to your router isn't damaged.
- Ensure that your Internet connection isn't down or disabled. (Open a browser on your computer to check.)

Table 2: Drive Light (bottom)

State	Status
White steady	Drive installed and ready for use
Off	Drive not properly installed or experiencing a problem

If the Drive light indicates a problem:

- Ensure that the drive is properly and fully connected to the dock.
- Ensure that neither the dock nor the drive is damaged.

Finding More Help

The GoFlex Home network storage system is easy to use, but you may still have questions. Go to www.seagate.com/goflexhomesupport if you have any problems setting up or using your GoFlex Home network storage system.

Index

A

- accessing files from home 40
- accessing files while travelling 43
- Add New User 65
- Add to Share 58
- Add Users 64
- adding a user account 15, 64, 65
- adding capacity to GoFlex Home 69
- adding captions and tags to files 55
- adding files to a folder in Seagate Share 54
- adding files to a share 57
- adding folders to Seagate Share 53
- adding GoFlex Home applications 63
- adding Macs to GoFlex Home 26
- adding PCs to GoFlex Home 17
- Administration settings 71
- Allow Downloads for this Share 44
- Application Store panel 29
- applications, adding new 63
- automatic backups 39

B

- backing up your files 39
 - troubleshooting 73
- Backup folder 9, 36

C

- captions 55
- centralized printing 47
- Change button on Seagate Dashboard 29
- Change Password 62
- changing users on Seagate Dashboard 30
- ComputersBackup 19
 - installing 23
 - Seagate Share 71
- configuring Time Machine 24
- connecting GoFlex Home 10
- Content panel in Seagate Share 33

- Cooliris 8, 34, 53
- Copy and Paste 54, 55
- copying a folder in Seagate Share 54
- copying files in Seagate Share 55
- copying files to GoFlex Home 37
- Cover 34
- cover art for shares 59
- Create as Administrator 65
- Create New Contact 60
- creating a share 58
- creating user accounts 13, 22
- customizing GoFlex Home 62
- Cut and Paste 54

D

- Dashboard. *See* Seagate Dashboard
- Date and Time setting 71
- Delete 56
- Delete Contact 60
- deleting a share 60
- deleting a user account 65
- deleting files from Seagate Share 56
- deleting folders from Seagate Share 53
- Desktop Applications for Macs 19
- digital video players 48
- disabling access to shares 58
- DLNA 48
- Download 56, 59
- downloading files from a share 59
- downloading files from Seagate Share 56
- Drag and Drop 39
- Drive light 6, 11
- drives
 - adding a USB drive 66
 - formatting a USB drive 71
 - removing a USB drive 67
 - removing the GoFlex Home drive 67
 - replacing the GoFlex Home drive 69
 - restarting GoFlex Home 68
 - shutting down GoFlex Home 68
- Drives panel on Seagate Dashboard 29

E

Edit Contact 60
Edit User 66
editing a user account 65
e-mail address books for shares 60
e-mail address for system messages 13, 23, 70
Enable FTP access to the Internet 61
Enable FTP access to your local LAN 61
Enable Sharing 44

F

Facebook, copying photos to 45
files
 accessing from home 40
 accessing from Seagate Share 42
 accessing from SmartFolderShortcut 42
 accessing from the Seagate Dashboard 41
 accessing remotely 43
 accessing with FTP 61
 adding captions and tags in Seagate Share 55
 adding to a folder in Seagate Share 54
 automatic backups 39
 backing up 39
 copying in Seagate Share 55
 copying to GoFlex Home 37
 creating shares 43
 deleting from Seagate Share 56
 downloading from a share 59
 downloading from Seagate Share 56
 enjoying on media devices 48
 managing with Seagate Share 50
 moving in Seagate Share 54
 playing on gaming consoles 48
 removing from a share 57
 renaming in Seagate Share 55
 sharing 43
 uploading to GoFlex Home 37
 working in Seagate Share 34
Flickr, copying photos to 46
folders
 adding files in Seagate Share 54
 adding to Seagate Share 53
 copying in Seagate Share 54

deleting from Seagate Share 53
managing with Seagate Share 50
moving files in Seagate Share 54
moving in Seagate Share 54
renaming in Seagate Share 54
working in Seagate Share 34

FTP 61

G

gaming consoles 48
Gateway 71
Get Cooliris 53
Go To menu 34
GoFlex Home
 adding a USB drive 66
 adding capacity 69
 adding Macs 26
 adding new applications 63
 adding PCs 17
 Backup folder 9, 36
 changing your password 62
 configuring Time Machine 24
 connecting 10
 customizing system settings 70
 customizing your settings 62
 Desktop Applications for Macs 23
 device features 6, 7
 device name 13, 21
 folders 9, 19, 36
 FTP access 61
 installing the software on Mac 20
 installing the software on Windows 12
 lights 6, 7, 74
 managing the device 62
 online support 75
 package contents 10
 Personal folder 9, 36
 privacy 37
 Public folder 9, 36
 registering 14, 22
 removing a USB drive 67
 removing the GoFlex drive 67
 resetting 68
 restarting 68

- setting up on Mac 20
- setting up on Windows 12
- shutting down 68
- troubleshooting 72
- updating the software 66
- GoFlex Home Agent 19
 - installing 23
- GoFlex Home light 6, 11
- GoFlex Home Premium Subscription 71
- H**
- Help 75
 - Seagate Dashboard 29
 - Seagate Share 34
- Hide Help Tips setting 63
- Home Background Position setting 63
- home network manager permissions 16, 65
- Home page
 - adding a background image 52
 - positioning the background image 63
- How to... panel on Seagate Dashboard 29
- I**
- installing GoFlex Home Desktop Applications 23
- installing GoFlex Home software on Mac 20
- installing GoFlex Home software on Windows 12
- Instant Backup 40
- inviting others to view your share 58
- IP addresses, finding 61, 74
- iTunes 50
- L**
- LAN Connection setting 70
- Language setting 63
- launching Seagate Dashboard 15
- LEDs/lights 6, 74
- listening to music 42, 43
- Load Content 37
- logging in to Seagate Share 31
- logging in to the Seagate Dashboard 18, 30
- M**
- Macs
 - adding to GoFlex Home 26
 - ComputersBackup 19
 - configuring Time Machine 24
 - Desktop Applications 19
 - GoFlex Home Agent 19
 - installing GoFlex Home Desktop Applications 23
 - installing the GoFlex Home software 20
 - listening to music 43
 - opening files 43
 - setting up GoFlex Home 20
 - SmartFolderShortcut 19
 - SmartWebShortcut 19
 - system requirements 6
 - viewing photos and pictures 43
 - watching movies and videos 43
- Main panel in Seagate Share 33
- Manual Upload 39
- media devices 48
 - examples 48
- Mimeo Instant Backup 39
- menus in Seagate Share 35
- movies
 - watching 42
 - watching with Seagate Share 51
- moving a folder in Seagate Share 54
- music
 - listening 42
 - playing in Seagate Share 50
 - playing with iTunes 50
- My Applications panel in Seagate Dashboard 29
- N**
- Navigation toolbar 34
- Network Services setting 70
- Network Sharing setting 70
- Notifications setting 70
- NTP 71
- O**
- Obtain IP Address Automatically 70
- opening files 42, 43
- opening Seagate Share 31
- opening Seagate Share menus 35

opening the Seagate Dashboard 28

P

package contents 10

passwords 16

 changing your password 62

 troubleshooting 73

 user accounts 13, 22

PCs

 adding to GoFlex Home 17

 setting up GoFlex Home 12

 system requirements 5

permissions 16, 65

Personal folder 9, 36

photos

 creating a Home page background 52

 creating cover art for shares 59

 rotating in Seagate Share 52

 sharing on Facebook 45

 sharing on Flickr 46

 sharing with RSS feeds 46

 viewing 42, 43

 viewing in a slideshow 52

 viewing in Cooliris 53

 viewing in Seagate Share 51

playing music 50

Power button image 7

Preferences

 Add New User 65

 Administration settings 71

 Change Password 62

 ComputersBackup setting 71

 Date and Time 71

 Edit User 65

 LAN Connection 70

 Network Services 70

 Network Sharing 70

 Notifications 70

 opening the Preferences page 69

 Remote Access 71

 removing a USB drive 67

 Server Preferences settings 70

 shutting down GoFlex Home 68

 software updates 66

Storage Devices 71

UPNP Router Configuration 70

User settings 63

printer, setting up 47

privacy 37

problem-solving 72

Public folder 9, 36

R

Really Simple Syndication. *See* RSS

registering GoFlex Home 14, 22

Remote Access setting 71

removing a USB drive 67

removing files from a share 57

removing the GoFlex drive 67

Rename 54, 55, 58

renaming a folder in Seagate Share 54

renaming files in Seagate Share 55

renaming shares 58

Reset all 'Do not show...' setting 63

Reset button 68

 image 7

resetting GoFlex Home 68

Restart 68

restarting GoFlex Home 68

Resume Audio Playback setting 63

Rotate Clockwise 52

Rotate Counterclockwise 52

rotating a photo 52

RSS defined 8

RSS feeds 46

RSS icon image 47

S

Seagate Dashboard 15

 accessing your files 41

 adding a user account 15, 64

 adding new applications 63

 Application Store panel 29

 Change button 29

 changing users 30

 copying files to GoFlex Home 37

- desktop icon 28
- Drives panel 29
- features 30
- Help 29
- How to... panel 29
- logging in 18, 30
- My Applications panel 29
- navigating 29
- opening 28
- system tray icon 28
- updating the software 31
- Seagate Share
 - accessing your files 42
 - accessing your shares 57
 - adding a user account 65
 - adding captions to files 55
 - adding files to a folder 54
 - adding folders 53
 - adding tags to files 55
 - Administration settings 71
 - arrow button 38
 - configuring to work with iTunes 50
 - Content panel 33
 - Cooliris 53
 - copying a folder 54
 - copying files 55
 - copying files to GoFlex Home 38
 - copying photos to Facebook 45
 - copying photos to Flickr 46
 - creating a Home page background 52
 - creating a share 43
 - deleting a share 60
 - deleting files 56
 - deleting folders 53
 - downloading files 56, 59
 - features 35
 - Go To menu 34
 - GoFlex Home Premium Subscription 71
 - Help 34
 - Home page image 33
 - Main panel 33
 - managing files and folders 50
 - managing shares 56
 - menus 34, 35
 - moving a folder 54
 - moving files to new folders 54
 - navigating 33
 - Navigation toolbar 34
 - opening 31
 - opening menus 35
 - opening the Preferences page 69
 - opening the Shares page 57
 - playing music 50
 - renaming a folder 54
 - renaming files 55
 - rotating a photo 52
 - Search/View toolbar 34
 - Server Preferences settings 70
 - setting up an e-mail address book 60
 - Share panel 33
 - shares 43
 - Shares page 57
 - Shares panel 57
 - sharing photos with RSS feeds 46
 - signing in 31
 - SmartWebShortcut 19
 - viewing photos and pictures 51
 - viewing photos in a slideshow 52
 - viewing shares 44, 57
 - watching movies and videos 51
 - working with files and folders 34
- Seagate Share Pro 8
- Search/View toolbar 34
- Send Invitations 44
- Server IP Address 70
- Server Netmask 70
- Server Preferences settings 70
- Set date and time from the Internet 71
- setting up GoFlex Home
 - on Mac 20
 - on Windows 12
- Share new content... setting 63
- Share panel 33
- Share with Everyone 44
- Share with Facebook 45
- Share with Flickr 46
- Share with Friends 44, 60

- Share with Media Devices 48, 51
 - Share with Media Players 44
 - Share with Other Family Accounts 44
 - shares
 - accessing 57
 - adding files 57
 - creating 43
 - creating cover art 59
 - creating unshared shares 58
 - defined 43
 - deleting 60
 - disabling sharing 58
 - downloading files 59
 - finding 57
 - inviting others to view your share 58
 - opening 44, 57
 - removing files 57
 - renaming 58
 - setting up an e-mail address book 60
 - viewing 44, 57
 - Sharing Emails Sender setting 63
 - sharing photos on Facebook 45
 - sharing photos on Flickr 46
 - sharing photos with RSS feeds 46
 - sharing with media devices 48
 - sharing your files 43
 - Shuffle 34
 - Shut Down 68
 - shutting down GoFlex Home 68
 - signing in to Seagate Share 31
 - signing in to the Seagate Dashboard 30
 - Slideshow 52
 - slideshows in Seagate Share 52
 - SmartFolderShortcut 19, 36
 - accessing your files 42
 - installing 23
 - SmartWebShortcut 19, 32
 - installing 23
 - Social Networking Sites 45
 - software installation
 - on Mac 20
 - Windows 12
 - Software Updates 66
 - software, updating 31, 66
 - solving problems 72
 - Storage Devices 67, 71
 - system requirements 5
- T**
- tags 55
 - defined 55
 - Time Machine 24
 - troubleshooting 72
- U**
- Unshare with Media Devices 49
 - updating GoFlex Home software 66
 - updating the Seagate Dashboard 31
 - uploading files to GoFlex Home 37
 - UPNP Router Configuration setting 70
 - UPnP-AV 48
 - USB drives
 - adding to GoFlex Home 66
 - formatting with Seagate Share 71
 - removing from GoFlex Home 67
 - USB port image 7
 - USB printer, setting up 47
 - Use as Home Page Background 52
 - Use as Share Cover 59
 - user accounts 13, 22
 - adding 15, 64, 65
 - home network manager permissions 16, 65
 - password tips 16
 - users
 - deleting a user account 65
 - editing a user account 65
 - troubleshooting 72
- V**
- videos
 - watching 42
 - watching with Seagate Share 51
 - View This In 3D 53

viewing photos and pictures 42, 43

W

watching movies and videos 42, 43

Windows

adding computers to GoFlex Home 17

installing software 12

setting up GoFlex Home 12

Wipe 71